

Multifunction Digital Timer

700-HX
User Manual



Important User Information

Because of the variety of uses for the products described in this publication, those responsible for the application and use of this control equipment must satisfy themselves that all necessary steps have been taken to assure that each application and use meets all performance and safety requirements, including any applicable laws, regulations, codes and standards.

The illustrations, charts, sample programs and layout examples shown in this guide are intended solely for purposes of example. Since there are many variables and requirements associated with any particular installation, Allen-Bradley does not assume responsibility or liability (to include intellectual property liability) for actual use based upon the examples shown in this publication.

Rockwell Automation publication SGI-1.1, *Safety Guidelines for the Application, Installation and Maintenance of Solid-State Control* (available from your local Rockwell Automation sales office or Allen-Bradley distributor), describes some important differences between solid-state equipment and electromechanical devices that should be taken into consideration when applying products such as those described in this publication.

Reproduction of the contents of this copyrighted publication, in whole or part, without written permission of Rockwell Automation, is prohibited.

Throughout this manual we use notes to make you aware of safety considerations:

ATTENTION



Identifies information about practices or circumstances that can lead to personal injury or death, property damage or economic loss

Attention statements help you to:

- identify a hazard
- avoid a hazard
- recognize the consequences

IMPORTANT

Identifies information that is critical for successful application and understanding of the product.

European Communities (EC) Directive Compliance

If this product has the CE mark it is approved for installation within the European Union and EEA regions. It has been designed and tested to meet the following directives.

EMC Directive

This product is tested to meet the Council Directive 89/336/EC Electromagnetic Compatibility (EMC) by applying the following standards, in whole or in part, documented in a technical construction file:

- EN 50081-2 EMC — Generic Emission Standard, Part 2 — Industrial Environment
- EN 50082-2 EMC — Generic Immunity Standard, Part 2 — Industrial Environment

This product is intended for use in an industrial environment.

Low Voltage Directive

This product is tested to meet Council Directive 73/23/EEC Low Voltage, by applying the safety requirements of EN 61010-1 safety requirements for electrical equipment for measurement, control and laboratory use--Part 1 General Safety Requirements.

This equipment is classified as open equipment and must be mounted as instructed in an enclosure during operation to provide safety protection.

Preface

Manual Objectives

The purpose of this manual is to provide you with the additional information necessary to apply the 700-HX Multifunction Digital Timer. Described in this manual are methods for applying and troubleshooting this product.

Who Should Use This Manual

This manual is intended for qualified personnel responsible for setting up and servicing these devices. You must have previous experience with and a basic understanding of wiring diagrams, configuration procedures, related equipment, and safety precautions.

Counter/Timer Mode Explanation

In this manual we refer to the **Timer Output Modes** with the following designations:

A: Signal ON delay 1

A-1: Signal ON delay 2

A-2: Power ON delay 1

A-3: Power ON delay 2

B: Repeat Cycle 1

B-1: Repeat Cycle 2

D: Signal OFF delay

E: One Shot

F: Cumulative

Z: ON/OFF-duty adjustable repeat cycle

S: Stop Watch

toff: Flicker OFF start 1(Timer resets when power comes on)

ton: Flicker ON start 1 (Timer resets when power comes on)

toff-1: Flicker OFF start 2(Timer **does not** reset when power comes on)

ton-1: Flicker ON start 2 (Timer **does not** reset when power comes on)

Note: In this manual the 700-HX Multifunction Digital Timer will be referred to as “700-HX.” For further information, please refer to the Industrial Controls Catalog or www.ab.com/catalogs.

Product Overview

Bill of Material

Your 700-HX Multifunction Digital Timer product package includes the following items:

Item No.	Description	Quantity
700-HX	Digital Timing Relay	1
—	6-Language Instruction Sheet	1
—	Rubber Gasket	1

Basic Product Information

Cat. No.	Input Voltage	Output Modes	Timing Ranges	Sockets	Output	Pins
700-HX86SA17	100...240 V AC	A mode: Signal ON-Delay 1 A-1 mode: Signal ON-Delay 2 A-2 mode: Power ON-Delay 1 A-3 mode: Power On-Delay 2	0.000...9.999 s 0.000...99.99 s			
700-HX86SU24	12...24V DC 24V AC	B mode: Repeat Cycle 1 B-1 mode: Repeat Cycle 2 D mode: Signal OFF-delay E mode: One Shot F mode: Cumulative Z mode: On/Off duty adjustable repeat cycle S mode: stop watch toff: Flicker OFF start 1 ton: Flicker ON start 1 toff-1: Flicker OFF start 2 ton-1: Flicker ON start 2	0.000...999.9 s 0.000...9999 s 0.000...99 min. 59 s 0.000...999.9 min. 0.000...9999 min. 0.000...99 h 59 min. 0.000...999.9 h 0.000...9999 h	700-HN100 700-HN125	SPDT	8

Accessories (Order Separately)

Cat. No.	Description	Pkg. Qty.
700-HN100	Screw Terminal Tube Base Sockets — Panel or DIN Rail Mounting Guarded Terminal Construction 8-pin for use with Bulletin 700-HX timing relays. Order must be for 10 sockets or multiples of 10.	10
700-HN125	Screw Terminal Tube Base Sockets — Panel or DIN Rail Mounting Open Style Construction 8-pin for use with Bulletin 700-HX timing relays. Order must be for 10 sockets or multiples of 10. No retainer clip required.	10
199-DR1	DIN Rail Mounting Pack Standard 35 x 7.5 mm DIN Rail, 1 meter long, 10 rails per package. Order must be for 10 rails or multiples of 10.	10
700-HN108	Specialty Socket 8-pin backwired socket with solder terminals for use with Bulletin 700-HX timing relays. Order must be for 10 sockets or multiples of 10.	10
700-HN130	Frame Adapter For flush or door mounting of all Bulletin 700-HR and -HX timers.	1
700-HN132	Protective Cover Helps prevent tampering of timing and mode settings. Provides a degree of protection against water and dirt from entering the front of the relay. For use with all Bulletin 700-HRs and -HX timing relays.	1
700-N40	Pre-printed identification tags— contains 10 sheets of pre-printed and blank tags. Each sheet contains 13 sets of the markings CR...9CR, TR...9TR, M...9M, F, R, 1S, and 117 blank tags. Tags are peel-off with sticky backing for easy placement on relays.	10
700-N41	Blank identification tags— contains 10 sheets of blank identification tags for customer specialized printing. Each sheet contains 546 blank tags. Tags are peel-off with sticky backing for easy placement on relays.	10

Product Features

Block diagram

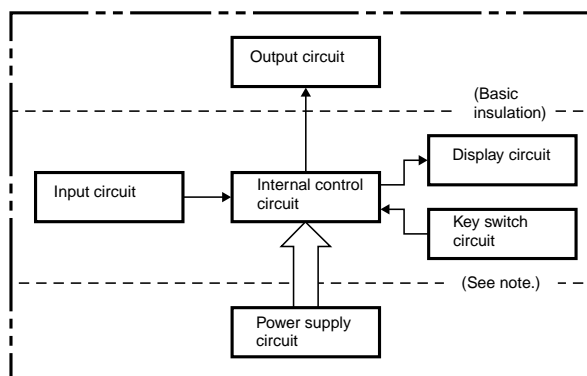

Note: 700-HX86SA17: Basic insulation is provided
 700-HX86SU24: Basic insulation is not provided

Inputs	Start signal	Stops timing in A-2 and A-3 (power ON delay) modes. Starts and stops timing in S mode. Start timing in other modes.
	Reset	Resets present value. (In elapsed time mode, the present value returns to 0; in remaining time mode, the present value returns to the set value.) Count inputs are not accepted and control output turns OFF while reset input is ON. Reset indicator is lit while reset input is ON.
	Gate ❶	Inhibits timer operation.
Outputs	Control output (OUT)	Outputs take place according to designated operating mode when timer reaches corresponding set value.

❶ Gate capability not available.

Engineering Data (Reference Values)

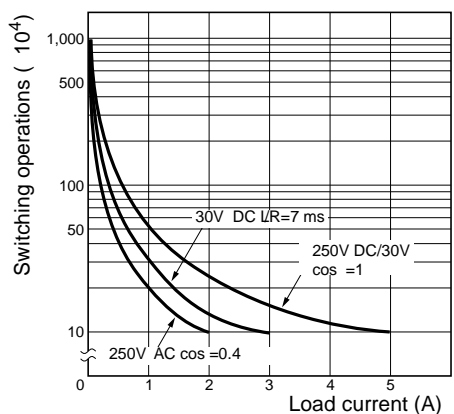

Reference: A maximum current of 0.15 A can be switched at 125V DC ($\cos\phi=1$) and a maximum current of 0.1 A can be switched if L/R is 7 ms. In both cases, a life of 100,000 operations can be expected. The minimum applicable load is 10 mA at 5V DC (failure level: P).

Specifications

Electrical Ratings		
Pilot Duty Rating		NEMA B300
Rated supply voltage		100 to 240V AC, 24V AC/12 to 24V DC (50/60Hz) (permissible ripple: 20%(p-p) max.)
Operating voltage range		85%...110% of rated supply voltage
Power consumption	100...240V AC	4.3 VA
	24V AC/12...24V DC	3.4 VA/1.7 W
Inrush Current	100...240V AC	3 A
	24V AC/12...24V DC	5 A
▶][◀ 120V AC		30 A
Make 240V AC		15 A
◀][▶ 120V AC		3 A
Break 240V AC		1.5 A
Hp at 120V AC		1/4 Hp
Hp at 240V AC		1/3 Hp
Mechanical		
Mounting method		Flush mounting, surface mounting, DIN mounting
Display		7-segment, negative transmissive LCD; Present value (red, 12 mm high characters); Set value (green, 6 mm high characters)
Digits		4 digits
Timer	Time ranges	0.000...9.999 s, 0.00...99.99 s, 0.0...999.9 s, 0...9999 s, 0 min. 0 s...99 min. 59 s, 0.0...999.9 min., 0 h 00 min...99 h 59 min., 0.0 h...999.9 h, 0 h...9999 h
	Timer modes	Elapsed time (Up), remaining time (Down), selectable
	Output modes	A, A-1, A-2, A-3, B, B-1, D, E, F, Z, S, toff, ton, toff-1, or ton-1

Electrical Ratings		
Inputs	Input signals	Start, reset
	Input method	No-voltage input via: NPN transistor or switching of contact
	Start, reset	Minimum input signal width: 1 or 20 ms (selectable)
	Power reset	Minimum power-opening time: 0.5 s (Except for A-3, B-1, and F mode)
Control output		SPDT contact output: 5 A at 250V AC, resistive load (cosine=1) Minimum applied load: 10 mA at 5V DC (failure level: P, reference value)
External Power Supply		No
Key Protect		Yes
Memory backup		EEP-ROM (overwritten 100,000 times min.), which can store data for 10 years min.
Accuracy of Operating Time and Setting Error ❶		Power-ON start: $\pm 0.01\%$ ± 50 ms max.* * to be rated against set value Signal start: ± 0.005 ± 30 ms max.* * to be rated against set value Signal start at transistor output model: $\pm 0.005\%$ ± 3 ms max. ❷ If the set value is within the sensor waiting time (250 ms max.)

❶ The values are based on the set value.

❷ The value is applied for a minimum pulse width of 1 ms.

Characteristics

Insulation resistance		100 M Ω min. (at 500V DC)
Dielectric strength		2000V AC, 50/60Hz for 1 min. between current-carrying terminals and non-current-carrying metal parts (1000V AC for 24V AC/12 to 24V DC type), 1000V AC, 50/60 Hz for 1 min. between non-continuous contacts
Noise immunity		' ± 1.5 kV (between power terminals) for 100 to 240V AC, ± 480 V for 24V AC/12 to 24VDC, and ± 600 V (between input terminals), square-wave noise by noise simulator (pulse width: 100 ns/1 μ s, 1-ns rise)
Static immunity		± 8 kV (malfunction), ± 15 kV (destruction)
Vibration resistance	Malfunction	10...55 Hz with 0.35 mm single amplitude each in three directions for 10 min.
Shock resistance	Malfunction	98 m/s ² (approx. 10 G) each in three directions
Life expectancy	Mechanical	10 million operations min.
	Electrical	100,000 operations min. (5 A at 250V AC, resistive load)
EMC		(EMI) EN61812-1 Emission Enclosure: EN55011 Group1 class A Emission AC mains: EN55011 Group1 class A (EMS) EN61812-1 Immunity ESD: EN61000-4-2: 4 kV contact discharge (level2) 8 kV air discharge (level3) Immunity RF-interference: EN61000-4-3: 10 V/m

Approved standards	UL508, CSA C22.2 No.14 Conforms to EN 61812-1 (Pollution degree 2/overvoltage category III) Conforms to VDE0106/P 100 (Finger Protection), conforms to NEMA output rating (N/F)
Enclosure ratings	Panel surface:IP66 and NEMA Type 4X (indoors) ❶
Weight	Approx. 100 g

❶ An attached waterproof packing is necessary to ensure IP66 waterproofing between the 700-HX and installation pan.

Nomenclature

Display Section

1. **Key Protect Indicator** (orange)
2. **Control Output Indicator** (orange)
3. **Reset Indicator** (orange)
4. **Present Value Display** (Main display)
(Character height: 12 mm, red *)
* Characters on models with screw terminals can be switched between red, green, and orange.
5. **Time Unit Indicators**
(Color is same as present value display.)
(If the time range is 0 min, 0 h, 0.0 h, or 0 h 0 min, these indicators flash to indicate timing operation.)
6. **Set Value Display** (Sub-display)
(Character height: 6 mm, green)
7. **Set Value 1, 2 Indicator** (green)

Character Size for Present Value Display

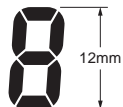

Character Size for Set Value Display

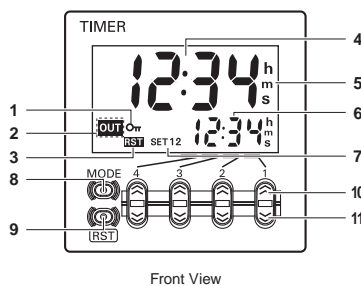

Front View

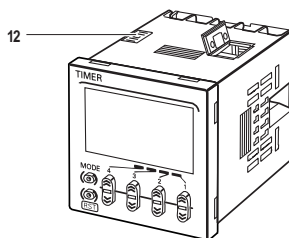

Operation Key

8. **Mode Key**
(Changes modes and setting items)
9. **Reset Key**
(Resets present value and output)
10. **Up Keys 1 to 4**
11. **Down Keys 1 to 4**

Switches

12. Key-protect Switch

(Default setting) OFF (Disabled) ↔ ON (Enabled)

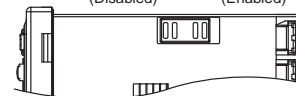

Explanations of Functions

Time Range (時間範囲)

Set the range to be timed in the range 0.000 s... 9,999 h. Use the operation keys if these settings are required.

Timer Mode (時間モード)

Set either the elapsed time (UP) or remaining time (DOWN) mode.

Output Mode (出力モード)

Set the output mode. The possible settings are A, A-1, A-2, A-3, B, B-1, D, E, F, Z and S. (For details on output mode operation, refer to “Timing Charts” on page 3-11.)

Output Time (出力時間)

When using one-shot output, set the output time for one-shot output (0.01... 99.99 s). One-shot output can be used only if the selected output mode is A, A-1, A-2, B, or B-1. If the output time is set to 0.00, HOLD is displayed, and the output is held.

Input Signal Width (入力信号幅)

Set the minimum signal input width (20 ms or 1 ms) for signal and reset inputs. The same setting is used for all external inputs (signal and reset). If contacts are used for the input signal, set the input signal width to 20 ms. Processing to eliminate chattering is performed for this setting. Set the key protect level.

Set Value Upper Limit (設定値上限)

Set the upper limit for the set value when it is set in Run Mode. The limit can be set to between 1 and 9999. This setting does not apply to the ON duty in Z mode.

Output ON Count Alarm Set Value (出力ON回数アラーム設定値)

Set the alarm value for the output ON count. The limit can be set to between 0 x 1000 times and 9999 x 1000 times. (The rightmost three digits will not be displayed.) If the total ON count of the output exceeds the alarm set value, e3 will be displayed on the Timer to indicate that the output ON count alarm value was exceeded.

Output ON Count Monitor Value (出力ON回数モニター値)

The monitor value is only displayed. It cannot be set. The value will be between 0 x 1000 times and 9999 x 1000 times. (The rightmost three digits will not be displayed.)

Key Protect Level (キープロテクト)

When the key-protect switch is set to ON, it is possible to prevent setting errors by prohibiting the use of certain operation keys by specifying the key protect level (KP-1 to KP-7). The key protect indicator is lit while the key-protect switch is set to ON. Confirm the ON/OFF status of the key-protect switch after the 700-HX is mounted to the panel.

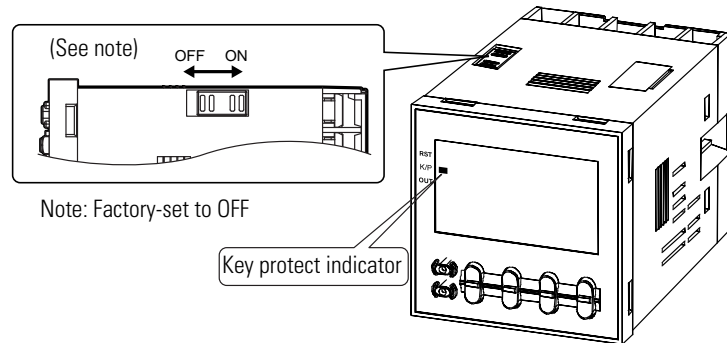

Level		Meaning
KP-1 (default setting)		Prohibits changing the mode to timer/repeat cycle selection mode or function setting mode. The 700-HX can only be used in run mode.
KP-2		Prohibits changing the mode to timer/repeat cycle selection mode or function setting mode. The 700-HX can only be used in run mode. Also prohibits use of the reset key.
KP-3		Prohibits changing the mode to timer/repeat cycle selection mode or function setting mode. The 700-HX can only be used in run mode. Also prohibits use of the up and down keys.
KP-4		Prohibits changing the mode to timer/repeat cycle selection mode or function setting mode. The 700-HX can only be used in run mode. Also prohibits use of the reset, up and down keys.
KP-5		Prohibits changing the mode to timer/repeat cycle selection mode or function setting mode. The 700-HX can only be used in run mode. Also prohibits use of any operation keys.
KP-6		Prohibits changing the mode to timer/repeat cycle selection mode or function setting mode. The 700-HX can only be used in run mode. Also prohibits use of the mode key.
KP-7		Prohibits changing the mode to timer/repeat cycle selection mode or function setting mode. The 700-HX can only be used in run mode. Also prohibits use of mode and reset keys.

Operation in Run Mode

When Output Mode Is Not Z

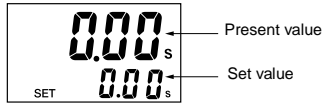

Set each digit for the set value using the corresponding \uparrow \downarrow keys.

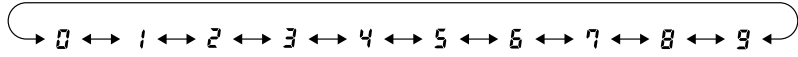

When Output Mode Z Is Selected

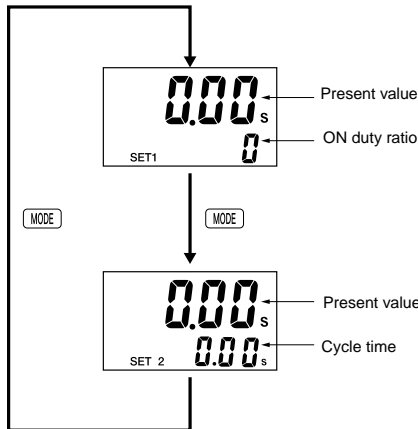

Set each digit for the ON duty ratio using the corresponding \uparrow \downarrow keys. (The \uparrow \downarrow keys for the 4th digit cannot be used.)

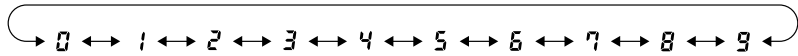

Set each digit for the cycle time using the corresponding \uparrow \downarrow keys.

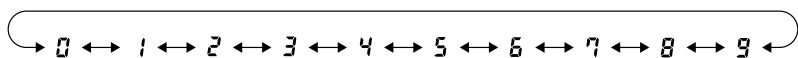

Present Value and Set Value

These items are displayed when the power is turned ON. The present value is displayed in the main display and the set value is displayed in the sub-display. The values displayed will be determined by the settings made for the time range and the timer mode in function setting mode.

Present Value and ON Duty Ratio (Output Mode = Z)

The present value is displayed in the main display and the ON duty ratio is displayed in the sub-display. “SET1” lights at the same time.

Set the ON duty ratio used in ON/OFF-duty adjustable Repeat Cycle (Z) as a percentage.

If a cycle time is set, cyclic control can be performed in ON/OFF-duty adjustable Repeat Cycle simply by changing the ON duty ratio.

Present Value and Cycle Time (Output Mode = Z)

The present value is displayed in the main display and the cycle time is displayed in the sub-display. “SET2” lights at the same time.

Set the cycle time used in ON/OFF-duty adjustable Repeat Cycle (Z).

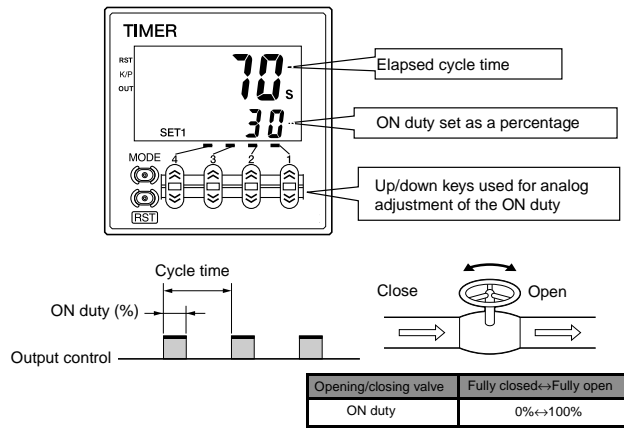

Operation (Repeat Cycle Function)

Switching from Timer to Repeat Cycle

The 700-HX is factory-set for timer operation. To switch to repeat cycle operation, use the procedure given below. For details, refer to page Appendix-2.

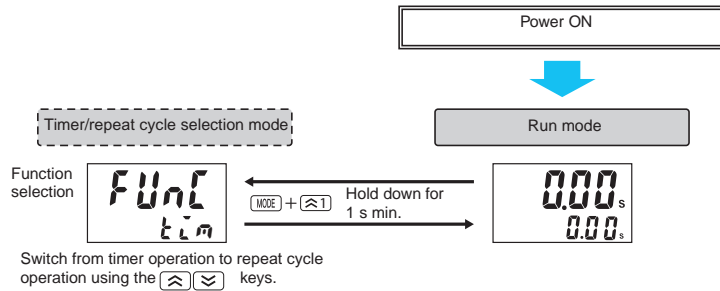

Settings for Advanced Functions

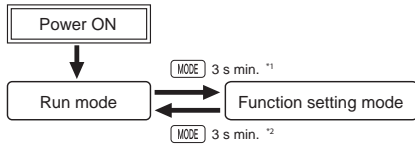

- *1. If the mode is switched to the function setting mode during operation, operation will continue.
- *2. Changes made to settings in function setting mode are enabled for the first time when the mode is changed to run mode. Also, when settings are changed, the timer is reset (time initialized and output turned OFF).

Function setting mode

- Set the OFF time range using the \uparrow \downarrow keys.

--:--s ← --:--s ← --:--s ← ← --:--h ← --:--s

 ➔ For details, refer to **Time Range List**.
- Set the ON time range using the \uparrow \downarrow keys.

--:--s ← --:--s ← --:--s ← ← --:--h ← --:--s

 ➔ For details, refer to **Time Range List**.
- Set the timer mode using the \uparrow \downarrow keys.

UP (UP) ↔ DOWN (DOWN)
- Set the repeat cycle mode using the \uparrow \downarrow keys.

tōFF ↔ tōn ↔ tōF I ↔ tōn I
 (Flicker OFF start 1) (Flicker On Start 1) (Flicker OFF start 2) (Flicker On Start 2)
- Set the input signal width using the \uparrow \downarrow keys.

20ms (20 ms) ↔ 1ms (1 ms)
- Set the NPN/PNP input mode using the \uparrow \downarrow keys.

nPn ↔ PnP
 (NPN input) (PNP input)
- Set the display color using the \uparrow \downarrow keys.

rEd ↔ Grn ↔ OrG ↔ r-G ↔ G-r ↔ r-ō ↔ ō-r ↔ G-ō ↔ ō-G
- Set the function (instantaneous or time-limit operation) for the instantaneous output (output 1) using the \uparrow \downarrow Keys.

IC IC ↔ 2C
 (Instantaneous) (Time-limit)

Display	Set Value
--:--s	0.01 s to 99.99 s (default setting)
--:--s	0.1 s to 999.9 s
--:--s	1 s to 9999 s
--:--s	0 min 01 s to 99 min 59 s
--:--m	0.1 min to 999.9 min
--:--m	1 min to 9999 min
--:--h	0 h 01 min to 99 h 59 min
--:--h	0.1 h to 999.9 h
--:--h	1 h to 9999 h
--:--s	0.001 s to 9.999 s

To next page From next page

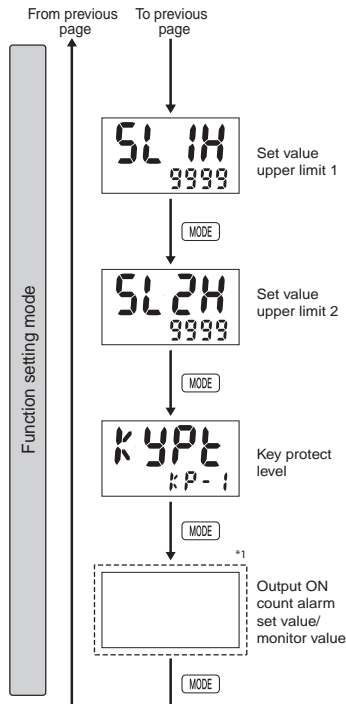

▪ Set the digits for the set value limit using the corresponding \leftarrow \rightarrow keys.

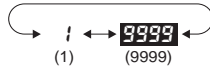

▪ Set the digits for the set value limit using the corresponding \leftarrow \rightarrow keys.



▪ Set the key protect level using the \leftarrow \rightarrow keys.

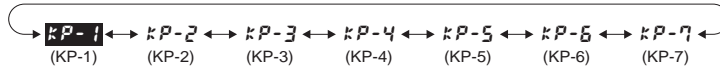

*1. Set the digits for the output ON alarm set value using the corresponding \leftarrow \rightarrow keys.

• Models without Instantaneous Contact Outputs

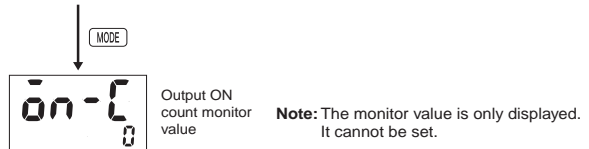
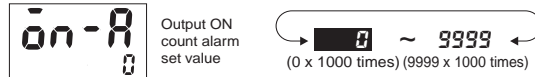

• Models with Instantaneous Contact Outputs

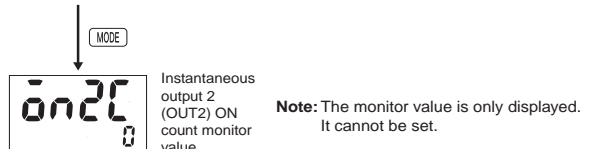
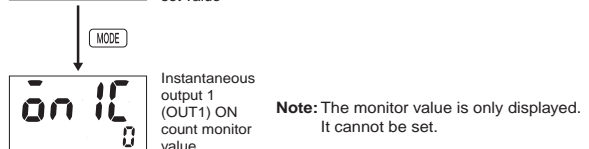
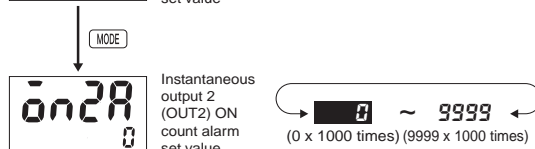
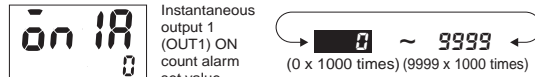

Explanation of Functions (Repeat Cycle Function)

OFF Time Range (OFFTR)

Set the time range for the OFF time in the range 0.000 s... 9,999 h. Use the operation keys if another type of setting is required.

ON Time Range (ONTR)

Set the time range for the ON time in the range 0.000 s ...9,999 h. Use the operation keys if another type of setting is required.

Timer Mode (TM)

Set either UP (incremental) or DOWN (decremental) timer mode. In UP mode, the elapsed time is displayed, and in DOWN mode, the remaining time is displayed.

ON/OFF Start Mode (OSTM)

Set the output mode. Set either Repeat Cycle OFF start or Repeat Cycle ON start. (For details on output mode operation, refer to 3-11.)

Input Signal Width (ISW) (Setting possible using DIP switch.)

Set the minimum signal input width (20 ms or 1 ms) for signal, reset, and gate inputs. The same setting is used for all external inputs (signal and rese). If contacts are used for the input signal, set the input signal width to 20 ms. Processing to eliminate chattering is performed for this setting.

Key Protect Level (KPL)

Set the key protect level.

When the key-protect switch is set to ON, it is possible to prevent setting errors by prohibiting the use of certain operation keys by specifying the key protect level (KP-1 to KP-7). The key protect indicator is lit while the key-protect switch is set to ON. Confirm the ON/OFF status of the key-protect switch after the 700-HX is mounted to the panel.

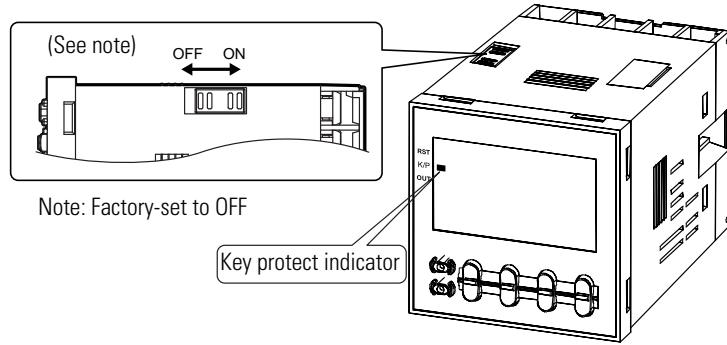

Level		Meaning
KP-1 (default setting)		Prohibits changing the mode to timer/repeat cycle selection mode or function setting mode. The 700-HX can only be used in run mode.
KP-2		Prohibits changing the mode to timer/repeat cycle selection mode or function setting mode. The 700-HX can only be used in run mode. Also prohibits use of the reset key.
KP-3		Prohibits changing the mode to timer/repeat cycle selection mode or function setting mode. The 700-HX can only be used in run mode. Also prohibits use of the up and down keys.
KP-4		Prohibits changing the mode to timer/repeat cycle selection mode or function setting mode. The 700-HX can only be used in run mode. Also prohibits use of the reset, up and down keys.
KP-5		Prohibits changing the mode to timer/repeat cycle selection mode or function setting mode. The 700-HX can only be used in run mode. Also prohibits use of any operation keys.
KP-6		Prohibits changing the mode to timer/repeat cycle selection mode or function setting mode. The 700-HX can only be used in run mode. Also prohibits use of the mode key.
KP-7		Prohibits changing the mode to timer/repeat cycle selection mode or function setting mode. The 700-HX can only be used in run mode. Also prohibits use of mode and reset keys.

Operation in Run Mode

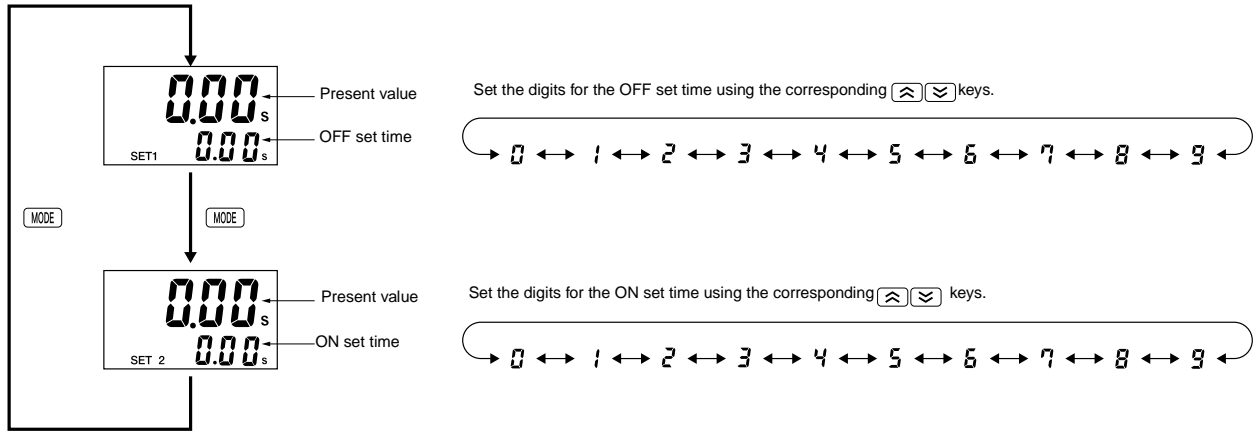

Present Value and OFF Set Time

The present value is displayed in the main display and the OFF set time is displayed in the sub-display. “SET1” lights at the same time.

Present Value and ON Set Time

The present value is displayed in the main display and the ON set time is displayed in the sub-display. “SET2” lights at the same time.

Operation in Timer/Repeat Cycle Selection Mode

Select whether the 700-HX is used as a timer or a repeat cycle in timer/repeat cycle selection mode.

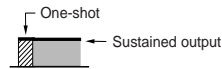

One-shot outputs can be set to 0.1 s, 0.5 s, 1s, 5 s, 10 s, 20 s.

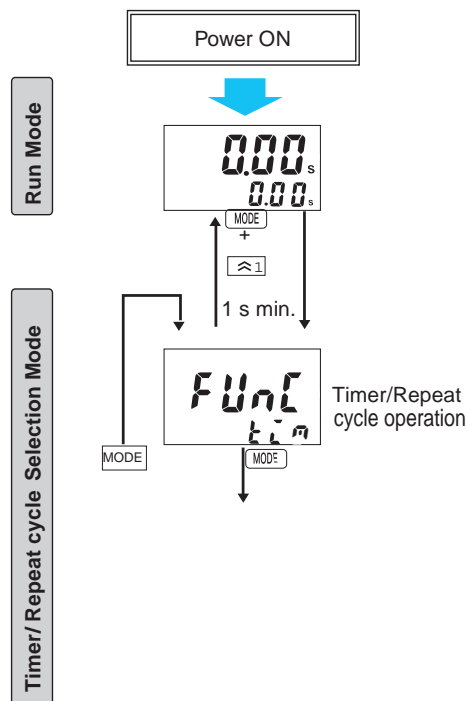

To change the mode to timer/repeat cycle selection mode, hold down the [1] key for 1 s min. with the [MODE] key held down. The [MODE] key must be pressed before the [1] key. If the [1] key is pressed first, the mode will not change.

Select either timer operation or repeat cycle operation using the [2] [3] keys.

Note: The 700-HX is factory-set for timer operation.

Note:

1. When the mode is changed to timer/repeat cycle selection mode, the present value is reset and output turns OFF. Timing operation is not performed in timer/repeat Cycle selection mode.
2. Setting changes made in timer/repeat cycle selection mode are enabled when the mode is changed to run mode. If settings are changed, the 700-HX is automatically reset (present value initialized, output turned OFF).

Timing Charts

The gate input is not included in the 700-HX.

Output mode A Mode: Signal ON-Delay (Timer resets when power comes ON.)

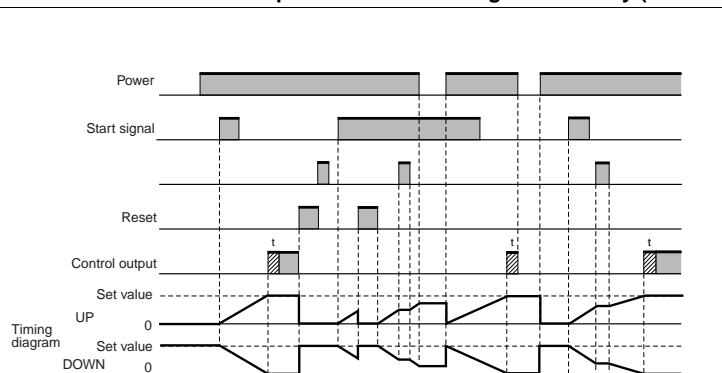

Timing starts when the start signal goes ON. While the start signal is ON, the timer starts when power comes ON or when the reset input goes OFF. The control output is controlled using a sustained or one-shot time period.

Basic Operation

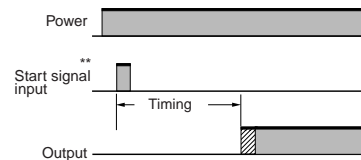

* Output is instantaneous when setting is 0.
 ** Start signal input is enabled during timing.

Output Mode A-1: Signal ON-Delay 2 (Timer resets when power comes ON.)

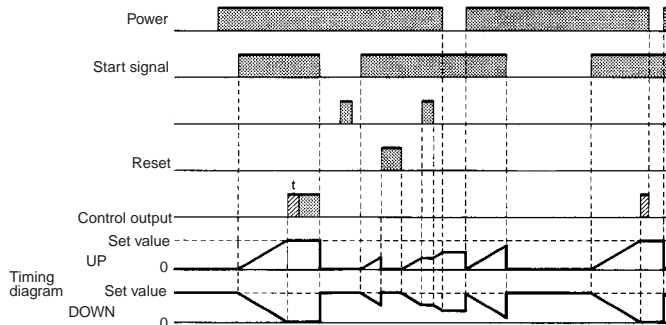

Timing starts when the start signal goes ON, and is reset when the start signal goes OFF. While the start signal is ON, the timer starts when the power comes ON or when the reset input goes OFF. The control output is controlled using a sustained or one-shot time period.

Basic Operation

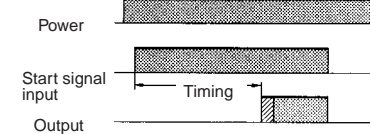

*Output is instantaneous when setting is 0.

Output mode A-2: Power ON Delay 1 (Timer resets when power comes ON)

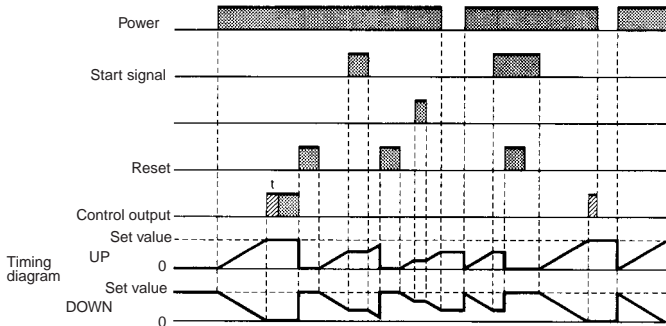

Timing starts when the reset input goes OFF. The start signal disables the timing function.

The control output is controlled using a sustained or one-shot time period.

Basic Operation

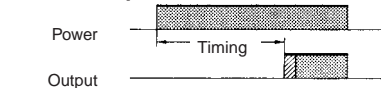

*Output is instantaneous when setting is 0.

Output mode A-3 Power ON Delay 2 (Timer does not reset when power comes ON)

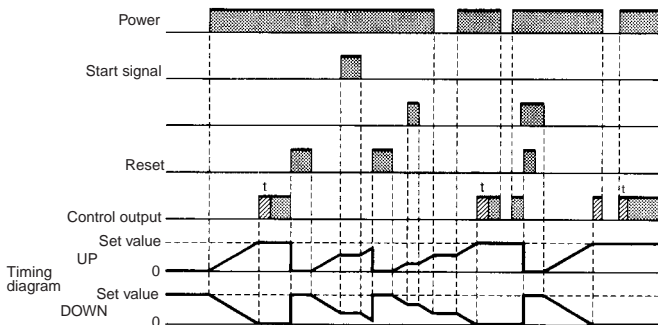

Timing starts when the reset input goes OFF. The start signal disables the timing function.

The control output is controlled using a sustained or one-shot time period.

Basic Operation

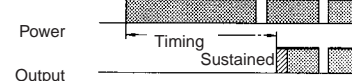

*Output is instantaneous when setting is 0.

Output mode B: Repeat Cycle 1 (Timer resets when power comes ON.)

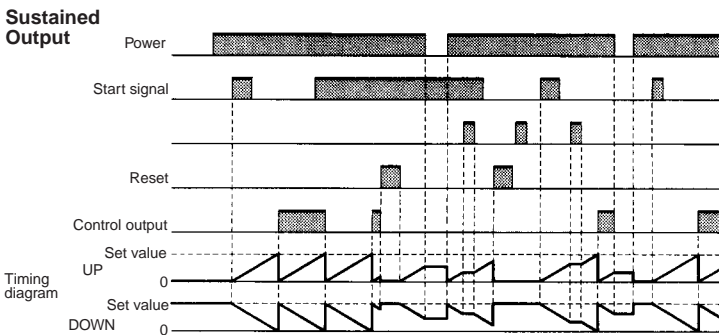

Timing starts when the start signal goes ON. The status of the control output is reversed when time is up (OFF at start). While the start signal is ON, the timer starts when the power comes ON or when the reset input goes OFF.

Basic Operation

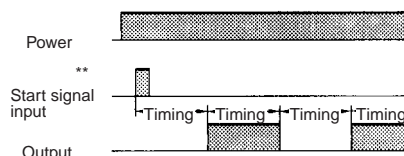

* Normal output operation will not be possible if the set time is too short. Set the value to at least 100 ms (contact output type).

** Start signal input is disabled during timing.

Output mode B: Repeat Cycle 1 (Timer resets when power comes ON.)

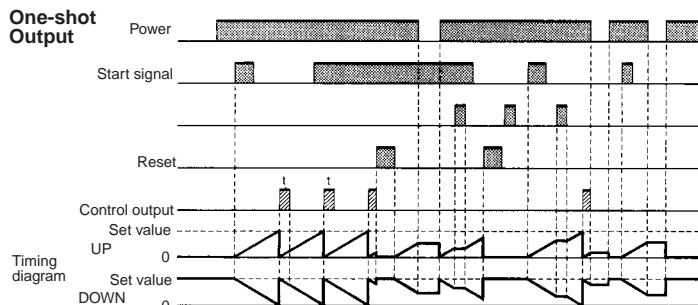

Timing starts when the start signal goes ON. The control output is turned ON when time is up. While the start signal is ON, the timer starts when the power comes ON or when the reset input goes OFF.

Basic Operation

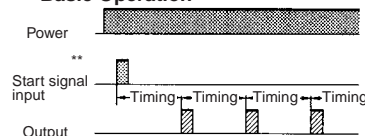

- * Normal output operation will not be possible if the set time is too short. Set the value to at least 100 ms (contact output type).
- ** Start signal input is disabled during timing.

Output Mode B-1: Repeat Cycle 2 (Timer does not reset when power comes ON)

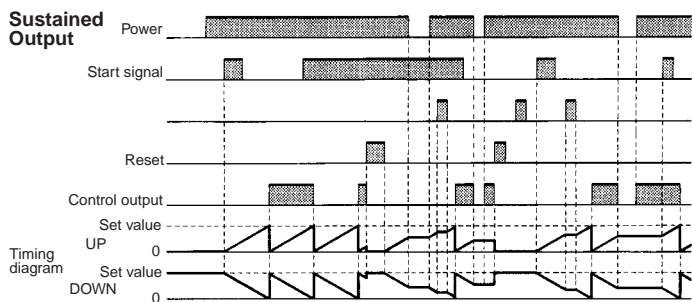

Timing starts when the start signal goes ON. The status of the control output is reversed when time is up (OFF at start). While the start signal is ON, the timer starts when the power comes ON or when the reset input goes OFF.

Basic Operation

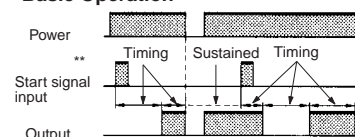

- * Normal output operation will not be possible if the set time is too short. Set the value to at least 100 ms (contact output type).
- ** Start signal input is disabled during timing.

One-shot Output

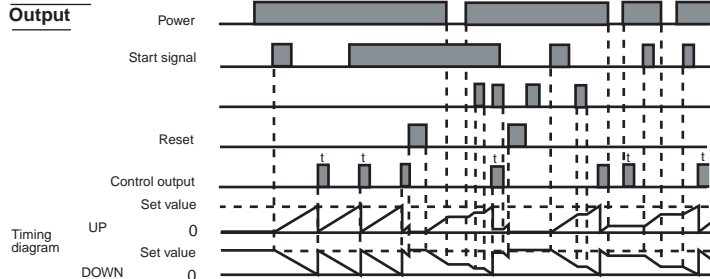

Timing starts when the start signal goes ON. The control output comes ON when time is up. While the start signal is ON, the timer starts when power comes ON or when the reset input goes OFF.

Basic Operation

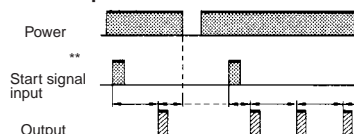

- * Normal output operation will not be possible if the set time is too short. Set the value to at least 100 ms (contact output type).
- ** Start signal input is disabled during timing.

Output mode D: Signal OFF-delay (Timer resets when power comes ON.)

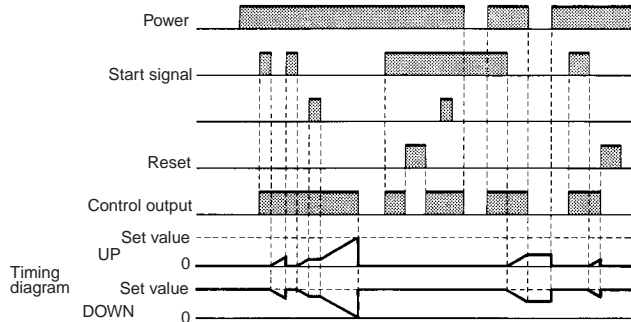

The control output is ON when the start signal is ON (except when the power is OFF or the reset is ON).

The timer is reset when the time is up.

Basic Operation

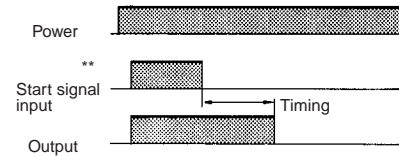

* Output functions only during start signal input when setting is 0.

** Start signal input is enabled during timing.

Output mode E: One Shot (Timer resets when power comes ON.)

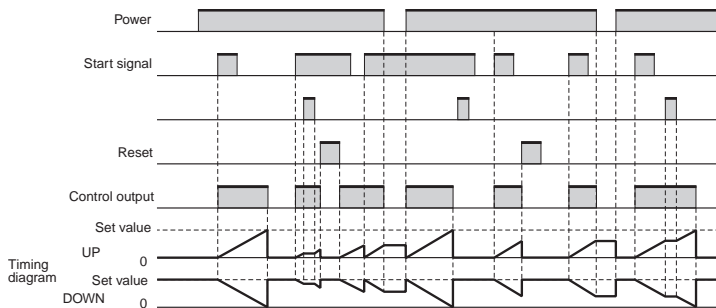

Timing starts when the start signal comes ON. The control output is reset when time is up. While the start signal is ON, the timer starts when power comes ON or when the reset input goes OFF.

Basic Operation

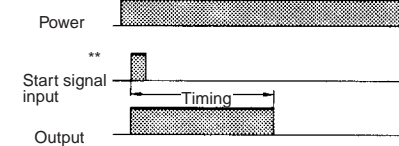

* Output is disabled when the setting is 0.

** Start signal input is enabled during timing.

Output Mode F: Cumulative (Timer does not reset when power comes ON)

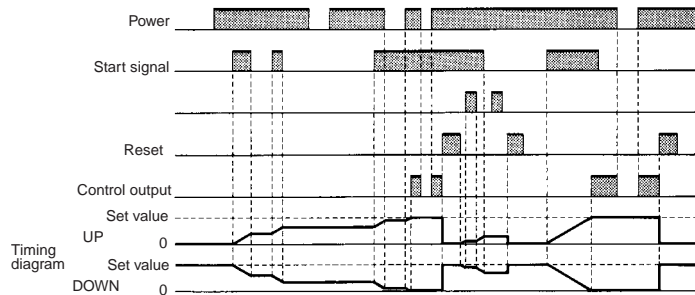

Start signal enables timing (timing is stopped when the start signal is OFF or when the power is OFF). A sustained control output is used.

Basic Operation

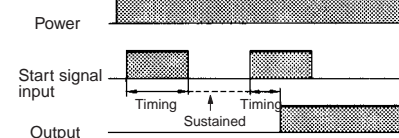

*Output is instantaneous when setting is 0.

Z Mode

Output quantity can be adjusted by changing the cycle time set in the adjustment level to 1 and by changing the ON duty (%) set value. The set value shows the ON duty (%) and can be set to a value between 0 and 100 (%). When the cycle time is 0, the output will always be OFF. When the cycle time is not 0 and when ON duty has been set to 0 (%), the output will always be OFF. When ON duty has been set to 100 (%), the output will always be ON.

Z mode: ON/OFF-duty Adjustable Repeat Cycle

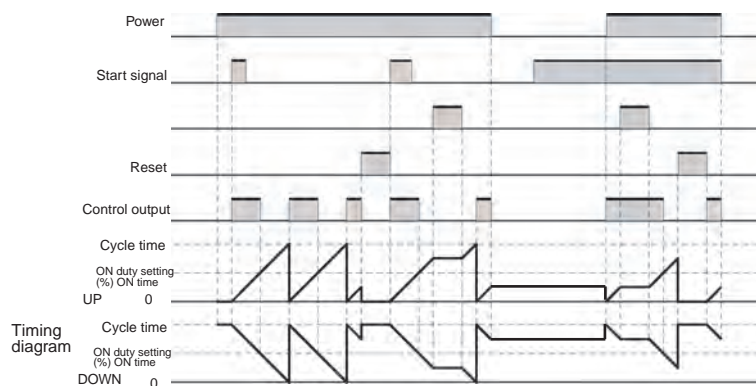

Timing starts when the start signal goes ON.
The status of the control output is reversed when time is up (ON at start).
While the start signal is ON, the timer starts when power comes ON or when the reset input goes OFF.

Basic Operation

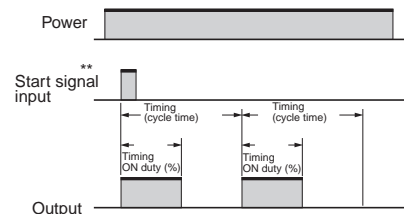

* Normal output operation will not be possible if the set time is too short. Set the value to at least 100 ms (contact output type).

** Start signal input is enabled during timing.

S mode: Stop Watch (Timer Resets when Power Comes On)

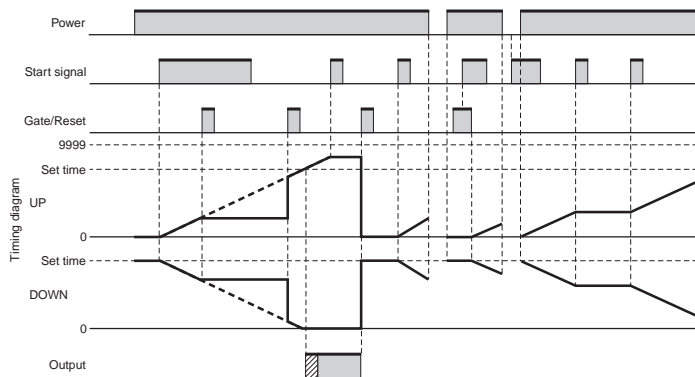

The signal starts and stops timing.
The display is held and timing is continued if the reset or gate input is received during timing operation.
The timer resets if the reset or gate input is received when the timing operation is stopped.

Basic Operation

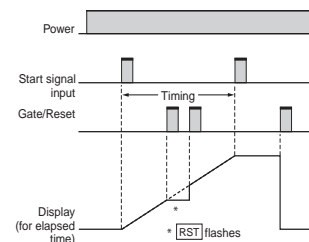

Note: Output is instantaneous when setting is 0.

Repeat Cycle Operation

Output mode TOFF: Flicker OFF start 1 (Timer resets when power comes ON)

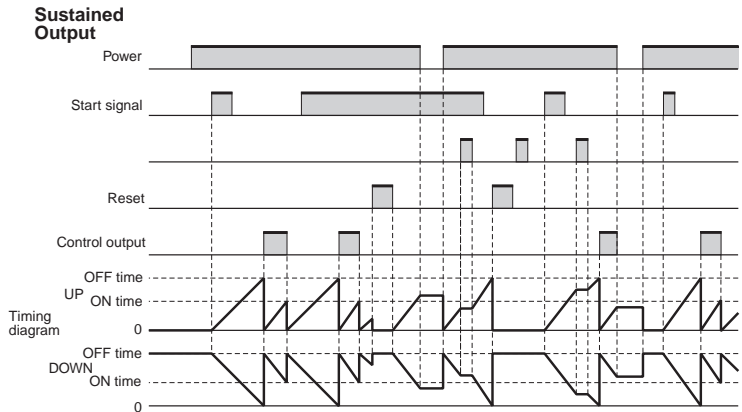

Timing starts when the start signal goes ON. The status of the control output is reversed when time is up (OFF at start). While the start signal is ON, the timer starts when the power comes ON or when the reset input goes OFF.

Basic Operation

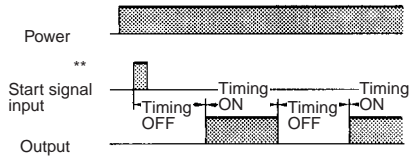

- * Normal output operation will not be possible if the ON/OFF set time is too short. Set the value to at least 100 ms (contact output type).
- ** Start signal input is disabled during timing.

Output mode TON: Flicker ON start 1 (Timer resets when power comes ON)

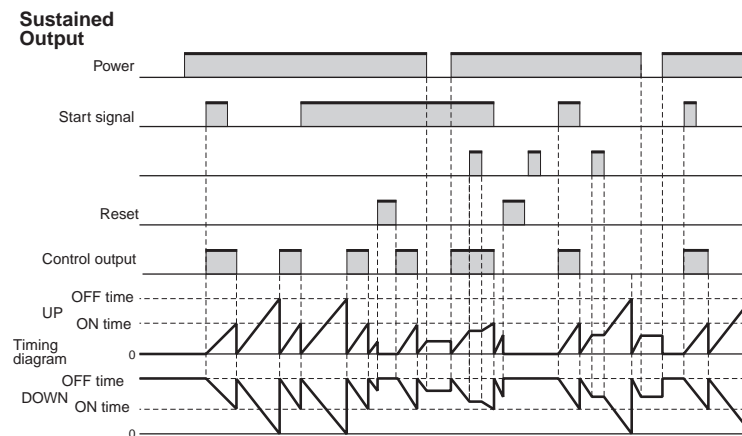

Timing starts when the start signal goes ON. The status of the control output is reversed when time is up (ON at start). While the start signal is ON, the timer starts when the power comes ON or when the reset input goes OFF.

Basic Operation

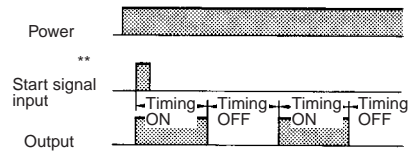

- * Normal output operation will not be possible if the ON/OFF set time is too short. Set the value to at least 100 ms (contact output type).
- ** Start signal input is disabled during timing.

Output mode TOFF-1: Flicker OFF start 2 (Timer does not reset when power comes ON)

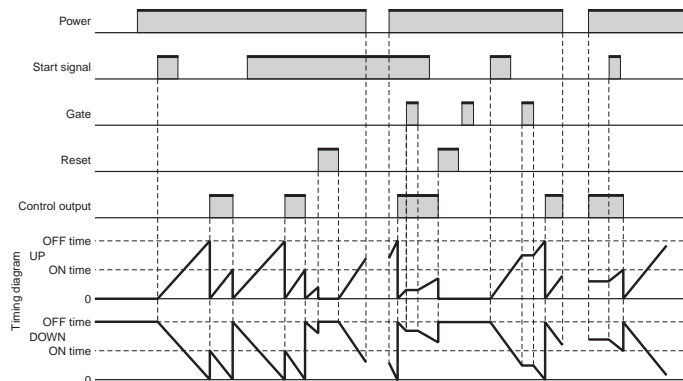

Timing starts when the start signal goes ON. The status of the control output is reversed when time is up (OFF at start). While the start signal is ON, the timer starts when the power comes ON or when the reset input goes OFF.

Basic Operation

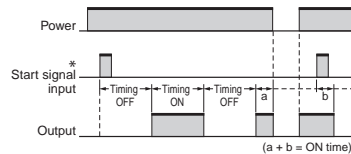

* Start signal input is disabled during timing.

Note: Normal output operation will not be possible if the set time is too short. Set the value to at least 100 ms (contact output type).

Output mode TON-1: Flicker ON start 2 (Timer does not reset when power comes ON)

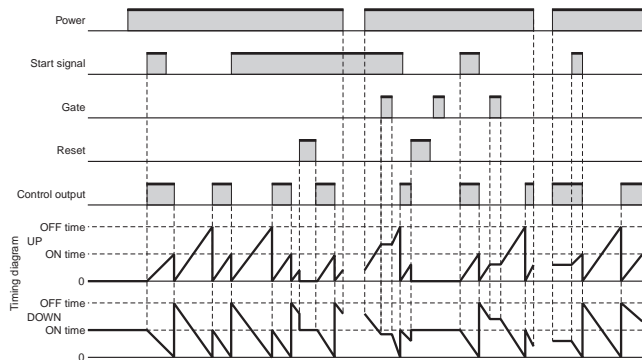

Timing starts when the start signal goes ON. The status of the control output is reversed when time is up (ON at start). While the start signal is ON, the timer starts when the power comes ON or when the reset input goes OFF.

Basic Operation

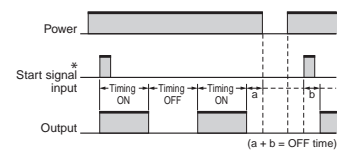

* Start signal input is disabled during timing.

Note: Normal output operation will not be possible if the set time is too short. Set the value to at least 100 ms (contact output type).

Dimensions

700-HX Flush Mounting/ Socket Mounting



Note: All units are in millimeters unless otherwise noted.

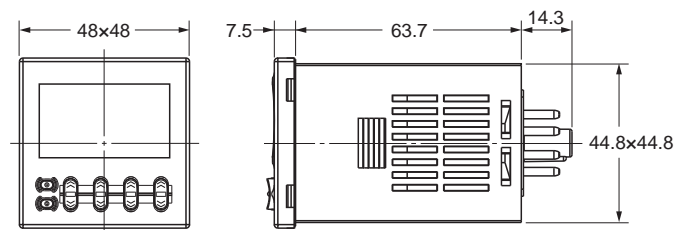

Panel Cutouts

Panel cutouts are as shown below (according to DIN43700).

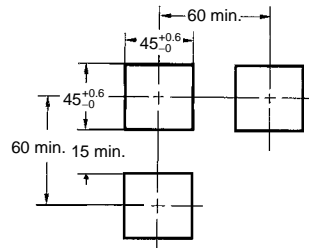

Note:

1. The mounting panel thickness should be 1...5 mm.
2. To allow easier operability, it is recommended that adapters are mounted so that the gap between sides with hooks is at least 15 mm.
3. It is possible to mount timers side by side, but only in the direction without the hooks.

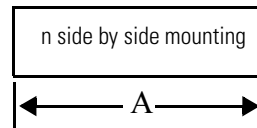

$$A = (48n - 2.5)^{+1}_0$$

With 700-HN132 attached:

$$A = (51n - 5.5)^{+1}_0$$

Installation

Terminal Arrangement

700-HX

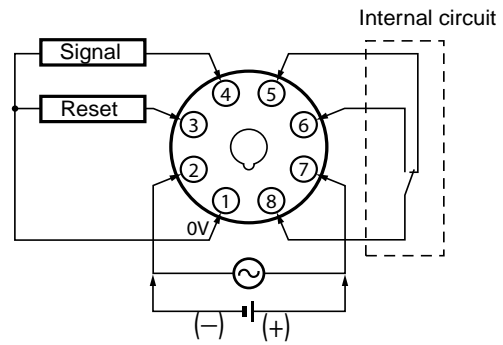

Note: Do not connect unused terminals as relay terminals.

Input Circuits

Start and reset Input

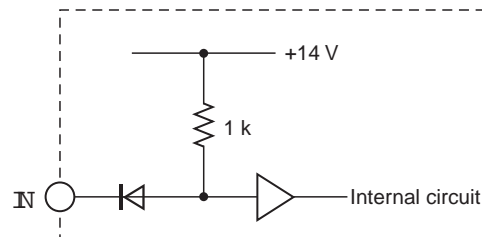

Input Connections

The input of the 700-HX is no-voltage input only.

No-voltage Inputs (NPN Inputs)

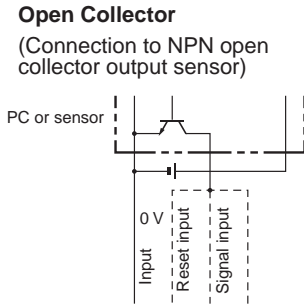

Operate with transistor ON

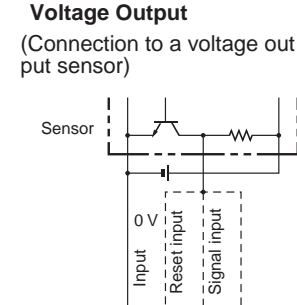

Operate with transistor ON

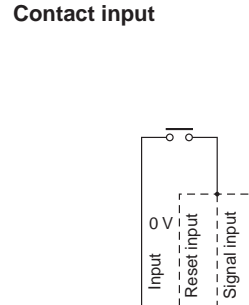

Operate with relay ON

No-voltage Input Signal Levels

No-contact input	Short-circuit level Transistor ON Residual voltage: 2 V max. Impedance when ON: 1 K Ω max. (the leakage current is approximately 12 mA when the impedance is 0 Ω)
	Open level Transistor OFF Impedance when OFF: 100 K Ω minimum.
Contact input	Use contact which can adequately switch 5 mA at 10V Maximum applicable voltage: 30V DC max.

Two-wire Sensor

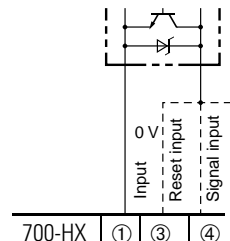

Applicable Two-wire Sensor

Leakage current: 1.5 mA max.

Switching capacity: 5 mA minimum

Residual voltage: 3V DC max.

Operating voltage: 10V DC

Precautions

ATTENTION

Do not use the product in locations subject to flammable or explosive gases. Doing so may result in explosion.



ATTENTION

The service life of the output relays depends on the switching capacity and switching conditions. Consider the actual application conditions and use the product within the rated load and electrical service life. Using the product beyond its service life may result in contact deposition or burning.



ATTENTION

Do not disassemble, repair, or modify the product. Doing so may result in electric shock, fire, or malfunction.



ATTENTION

Do not allow metal objects or conductive wires to enter the product. Doing so may result in electric shock, fire, or malfunction.



Power Supplies

Make sure that the voltage is applied within the specified range, otherwise the internal elements of the Timer may be damaged.

When turning the power ON and OFF, input signal reception is possible, unstable, or impossible as shown in the diagram below.

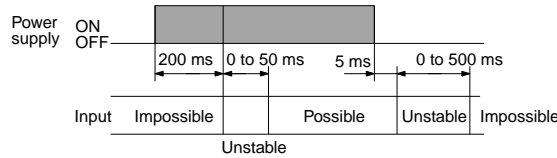

Turn the power ON and OFF using a relay with a rated capacity of 10 A minimum to prevent contact deterioration due to inrush current caused by turning the power ON and OFF.

Apply the power supply voltage through a relay or switch in such a way that the voltage reaches a fixed value immediately, otherwise they may not be reset or a timer error may result.

Be sure that the capacity of the power supply is large enough, otherwise the Timer may not start due to inrush current (approx. 5 A) that may flow for an instant when the Timer is turned on.

Make sure that the fluctuation of the supply voltage is within the permissible range.

Timer Control with Power Start

To allow for the startup time of peripheral devices (sensors, etc.), the 700-HX starts timing operation between 200 ms...260 ms after power is turned ON. For this reason, in operations where timing starts from power ON, the time display will actually start from 250 ms. If the set value is 249 ms or less, the time until output turns ON will be a fixed value between 200...250. (Normal operation is possible for set value of 250 ms or more.) In applications in which a set value of 249 ms or less is required, use start timing with signal input.

When the 700-HX is used with power start in F mode (i.e., accumulative operation with output on hold), there will be a timer error (approximately 100 ms each time the 700-HX is turned ON) due to the characteristics of the internal circuitry. Use the 700-HX with signal start if timer accuracy is required.

Self-diagnostic Function

The following displays will appear if an error occurs.

Confirm the error type using the display, and take the appropriate countermeasures.

Main display	Sub- display	Error	Correction
<i>E1</i>	No display	CPU	Either press the reset key or reset the power supply.
<i>E2</i>	No display	Memory (RAM)	Reset the power supply. If normal operation is still not restored, replacement or repair is necessary. If normal operation is restored, the cause may have been noise.
<i>E2</i>	<i>SUM</i>	Memory (EEP) ❶	Reset to the factory settings using the reset key.
<i>E3</i> ❷	No Change	Output ON count alarm set value exceeded	Reset key

❶ This includes times when the life of the EEPROM has expired.

❷ The normal display and *E3* will appear alternately. When the Reset Key is pressed, *E3* will no longer be displayed even if the alarm set value is exceeded. (Monitoring is possible, however, because the Timer will continue without clearing the output ON count.)

Changing the Set Values

When changing the set value during a timing operation, the output will turn ON if the set value is changed as follows because of the use of a constant read-in system:

Elapsed time mode: Present value \geq set value

Remaining time mode: Elapsed time \geq set value (The present value is set to 0.)

NOTE: When in the remaining time mode, the amount the set value is changed is added to or subtracted from the present value.

Operation with a Set Value of 0

Operation with a set value of 0 will vary with the output mode. Refer to 3-11.

Power Failure Backup

All data is stored in the EEPROM when there is power failure. The EEPROM can be overwritten more than 100,000 times.

Operating mode	Overwriting timing
A-3, b-1, F, toff-1/ ton-1 mode	When power is turned OFF.
Other mode	When settings are changed.

Wiring

Wiring input lines in the same conduit as power lines or other high-voltage lines may result in malfunction due to noise. Wire the input lines separately, away from lines carrying high-voltages. In addition, make the input wiring as short as possible and use shield lines or metal wiring conduits.

Mounting

Dense mounting may result in a reduction in the service life of internal parts.

Tighten the two mounting screws on the Adaptor. Tighten them alternately, a little at a time, so as to keep them at an equal tightness.

The 700-HX panel surface is water-resistant (conforming to NEMA 4 and IP66). In order to prevent the internal circuit from water penetration through the space between the timer and operating panel, attach a waterproof gasket between the timer and installation panel and secure the waterproof gasket with the 700-HN130 flush-mounting adapter.

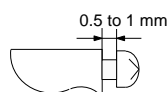

It is recommended that the space between the screw head and the adapter should be 0.5 to 1 mm.

Operating Environment

- Use the product within the ratings specified for submerging in water, and exposure to oil.
- Do not use the product in locations subject to vibrations or shocks. Using the product in such locations over a long period may result in damage due to stress.
- Do not use the product in locations subject to dust, corrosive gases, or direct sunlight.
- Separate the input signal devices, input signal cables, and the product from the source of noise or high-tension cables producing noise.
- Separate the product from the source of static electricity when using the product in an environment in which a large amount of static electricity is produced (e.g., forming compounds, powders, or fluid materials being transported by pipe).

- Organic solvents (such as paint thinner), as well as very acidic or basic solutions might damage the outer casing of the timer.
- Use the product within the ratings specified for temperature and humidity.
- Do not use the product in locations where condensation may occur due to high humidity or where temperature changes are severe.
- Store at the specified temperature. If the 700-HX has been stored at a temperature of less than -10°C , allow the 700-HX to stand at room temperature for at least 3 hours before use.
- Leaving the 700-HX with outputs ON at a high temperature for a long time may hasten the degradation of internal parts (such as electrolytic capacitors). Therefore, use the product in combination with relays and avoid leaving the product as long as more than 1 month with the output turned ON.

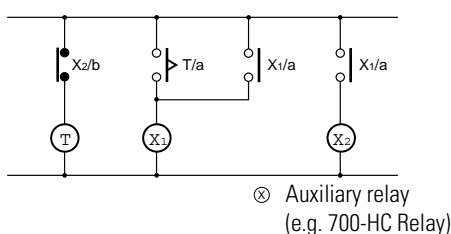

Insulation

There is no insulation between power supply and input terminals.

Basic insulation between power supply and output terminals.

Input and output terminals are connected to devices without exposed charged parts.

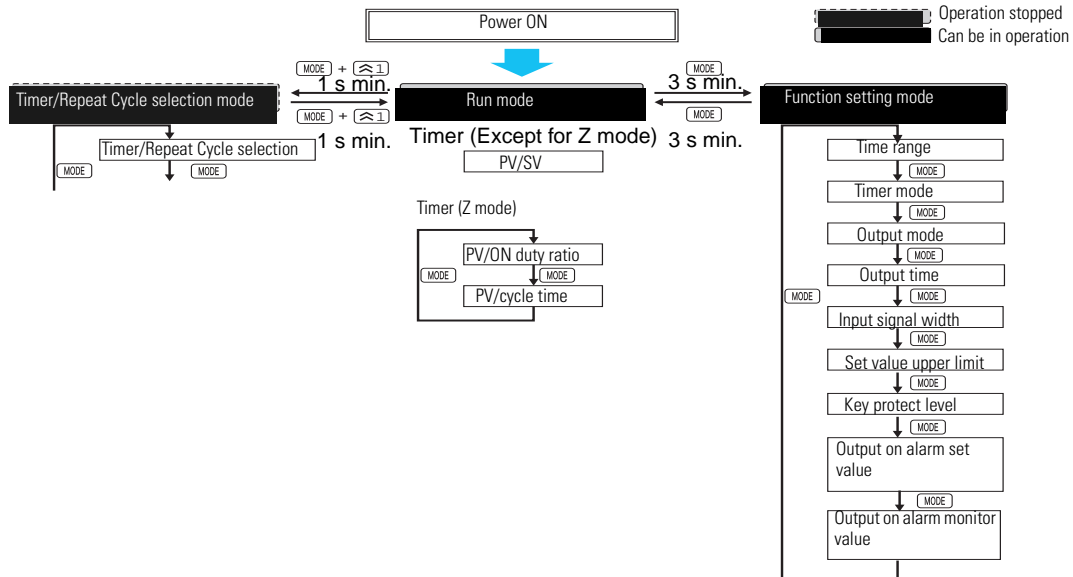

Input and output terminals are connected to devices with basic insulation that is suitable for the maximum operating voltage.

Using the Operation Keys *Timer Operation*

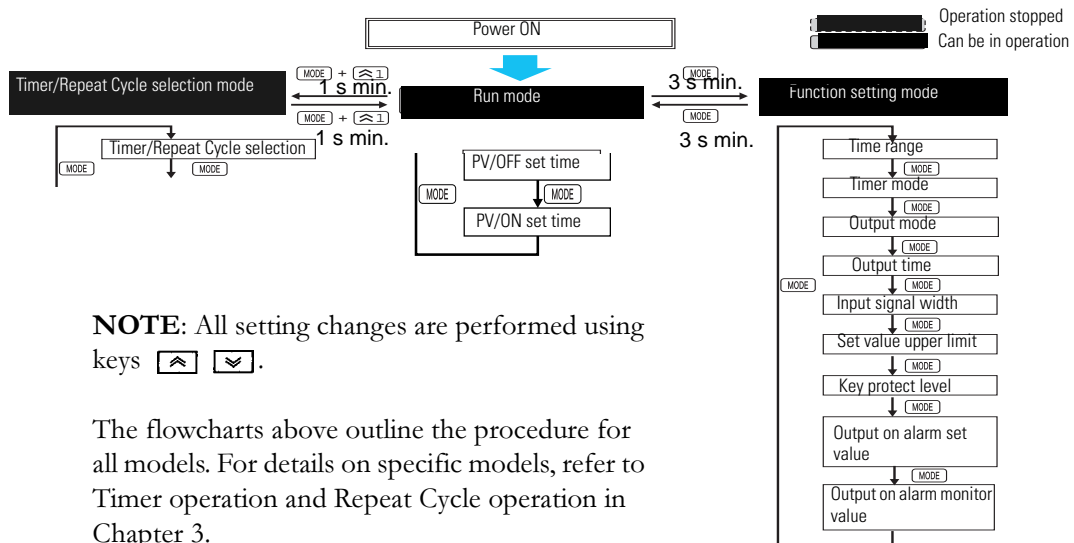

Repeat Cycle Operation



NOTE: All setting changes are performed using keys  .

The flowcharts above outline the procedure for all models. For details on specific models, refer to Timer operation and Repeat Cycle operation in Chapter 3.

List of Settings

Fill in your set values in the set value column of the following tables for quick reference.

Timer/Repeat Cycle Selection Mode

Parameter name	Parameter	Setting range	Default value	Unit	Set value
Timer/Repeat Cycle selection	PLN	PLM/PLN	PLM	---	

Settings for Timer Operation

Run Mode when Output Mode is Not Z

Parameter name	Parameter	Setting range	Default value	Unit	Set value
Present value, set value	Set value	0.00 ... 99.99 (Time range: --,-s)	0.00	s	
		0.0 ... 999.9 (Time range: ---,-s)	0.0	s	
		0 ... 9999 (Time range: ----s)	0	s	
		0:00 ... 99:59 (Time range: --min--s)	0:00	min; s	
		0.0 ... 999.9 (Time range: ---,-min)	0.0	min	
		0 ... 9999 (Time range: ----min)	0	min	
		0:00 ... 99:59 (Time range: --h--min)	0:00	h; min	
		0.0 ... 999.9 (Time range: ---,-h)	0.0	h	
		0 ... 9999 (Time range: ----h)	0	h	
		0.000 ... 9.999 (Time range: -,-s)	0.000	s	
Present value		Same as set value	Same as left	Same as left	

Run Mode when Output Mode = Z

Parameter name	Parameter	Setting range	Default value	Unit	Set value
Present value, cycle time	Cycle time	0.00 ... 99.99 (Time range: --,-s)	0.00	s	
		0.0 ... 999.9 (Time range: ---,-s)	0.0	s	
		0 ... 9999 (Time range: ----s)	0	s	
		0:00 ... 99:59 (Time range: --min--s)	0:00	min; s	
		0.0 ... 999.9 (Time range: ---,-min)	0.0	min	
		0 ... 9999 (Time range: ----min)	0	min	
		0:00 ... 99:59 (Time range: --h--min)	0:00	h; min	
		0.0 ... 999.9 (Time range: ---,-h)	0.0	h	
		0 ... 9999 (Time range: ----h)	0	h	
		0.000 ... 9.999 (Time range: -,-s)	0.000	s	
Present value		Same as cycle time above	Same as left	Same as left	
Present value, ON duty ratio	ON duty ratio	0... 100	0	%	
	Present value		Same as cycle time above	Same as left	Same as left

Function Setting Mode

Parameter name	Parameter	Setting range	Default value	Unit	Set value
Time range	tiān	--,-s/---,-s/----s/--min--s/ ---,-min/----min/--h--min/ ---,-h/----h/-,-s		---	
Timer mode	tiān	UP dān	UP	---	
Output mode	ōutān	A A-1 A-2 A-3 b b-1 d E F S	A	---	
Output time	ōtān	Hōld 0.01 to 99.99	Hōld	s	
Input signal width	īflē	20ms 1ms	20ms	---	
Key protect level	kypē	kP-1 kP-2 kP-3 kP-4 kP-5 kP-6 kP-7	kP-1	---	

Settings for Repeat Cycle Operation

Run Mode

Parameter name	Parameter	Setting range	Default value	Unit	Set value
Present value, OFF set time	OFF set time	0.00 ... 99.99 (Time range: --,--s)	0.00	s	
		0.0 ... 999.9 (Time range: ---,--s)	0.0	s	
		0 ... 9999 (Time range: ----s)	0	s	
		0:00 ... 99:59 (Time range: --min--s)	0:00	min; s	
		0.0 ... 999.9 (Time range: ---,-min)	0.0	min	
		0 ... 9999 (Time range: ----min)	0	min	
		0:00 ... 99:59 (Time range: --h--min)	0:00	h; min	
		0.0 ... 999.9 (Time range: ---,-h)	0.0	h	
		0 ... 9999 (Time range: ----h)	0	h	
		0.000 ... 9.999 (Time range: -,---s)	0.000	s	
Present value		Same as OFF set time above	Same as left	Same as left	
Present value, ON set time	ON set time		Same as left	Same as left	
	Present value		Same as left	Same as left	

Function Setting Mode

Parameter name	Parameter	Setting range	Default value	Unit	Set value
OFF time range	ōFtṛ	--,-s/---,-s/----s/--min--s/ ---,-min/----min/--h--min/ ---,h/----h/-,-s	--,-s	---	
ON time range	ōntṛ	--,-s/---,-s/----s/--min--s/ ---,-min/----min/--h--min/ ---,h/----h/-,-s	--,-s	---	
Timer mode	ṫṫm	UP dōwn	UP	---	
ON/OFF start mode	ṫōṫm	ṫōFF ṫōno ṫōFF-1 ṫōno-1	ṫōFF	---	
Input signal width	ṫFLṫ	20mS 1mS	20mS	---	
Key protect level	ṫYPṫ	ṫP-1 ṫP-2 ṫP-3 ṫP-4 ṫP-5 ṫP-6 ṫP-7	ṫP-1	---	

Allen-Bradley is a registered trademark of Rockwell Automation

www.rockwellautomation.com

Power, Control and Information Solutions Headquarters

Americas: Rockwell Automation, 1201 South Second Street, Milwaukee, WI 53204 USA, Tel: (1) 414.382.2000, Fax: (1) 414.382.4444

Europe/Middle East/Africa: Rockwell Automation, Vorstlaan/Boulevard du Souverain 36, 1170 Brussels, Belgium, Tel: (32) 2 663 0600, Fax: (32) 2 663 0640

Asia Pacific: Rockwell Automation, Level 14, Core F, Cyberport 3, 100 Cyberport Road, Hong Kong, Tel: (852) 2887 4788, Fax: (852) 2508 1846