



Allen-Bradley

1784-PKTx Network Interface Card

1784-PKTX, -PKTXD

User Manual

**Rockwell
Automation**

Important User Information

Solid state equipment has operational characteristics differing from those of electromechanical equipment. *Safety Guidelines for the Application, Installation and Maintenance of Solid State Controls* (Publication SGI-1.1 available from your local Rockwell Automation sales office or online at <http://www.ab.com/manuals/gi>) describes some important differences between solid state equipment and hard-wired electromechanical devices. Because of this difference, and also because of the wide variety of uses for solid state equipment, all persons responsible for applying this equipment must satisfy themselves that each intended application of this equipment is acceptable.





In no event will Rockwell Automation, Inc. be responsible or liable for indirect or consequential damages resulting from the use or application of this equipment.

The examples and diagrams in this manual are included solely for illustrative purposes. Because of the many variables and requirements associated with any particular installation, Rockwell Automation, Inc. cannot assume responsibility or liability for actual use based on the examples and diagrams.

No patent liability is assumed by Rockwell Automation, Inc. with respect to use of information, circuits, equipment, or software described in this manual.

Reproduction of the contents of this manual, in whole or in part, without written permission of Rockwell Automation, Inc. is prohibited.

Throughout this manual we use notes to make you aware of safety considerations.

<p>WARNING</p> 	Identifies information about practices or circumstances that can cause an explosion in a hazardous environment, which may lead to personal injury or death, property damage, or economic loss.
<p>IMPORTANT</p>	Identifies information that is critical for successful application and understanding of the product.
<p>ATTENTION</p> 	Identifies information about practices or circumstances that can lead to personal injury or death, property damage, or economic loss. Attentions help you: <ul style="list-style-type: none">• identify a hazard• avoid a hazard• recognize the consequence
<p>SHOCK HAZARD</p> 	Labels may be located on or inside the drive to alert people that dangerous voltage may be present.
<p>BURN HAZARD</p> 	Labels may be located on or inside the drive to alert people that surfaces may be dangerous temperatures.

Introduction

This manual describes how to install, configure, and troubleshoot the 1784-PKT_x and -PKT_{XD} network interface cards. Throughout the manual, we refer to this product as the PKT_x card. When one card differs from the other, this document individually calls out the cards by name.

Contents of Your Package

With this package you should receive:

- one 1784-PKT_x network interface card
- one 1784-PKT_x Network Interface Card User Manual, publication 1784-UM527B-EN-P

If you are missing any of these pieces, contact your Allen-Bradley distributor.

Abbreviations

Throughout this manual, we abbreviate some terms. Use this table to become familiar with our terminology.

This is the abbreviation	for
BIOS	Basic Input/Output System
ESD	Electrostatic Discharge
IRQ	Interrupt Request
ISA	Industry-Standard Architecture
NIC	Network Interface Card
ORB	Outside Retaining Bracket
PCI	Peripheral Component Interconnect
PC	Personal Computer
RIO	Remote I/O

Conventions

We use these conventions in this manual:

- Screen displays and prompts are shown as
Press ENTER to continue with the installation
- Text that you type is shown as:
a:\install c
- Keys that you press look like this: 
- Other actions to be performed are shown as:
Click on the Memory tab.

Environment and Enclosure

ATTENTION

This equipment is intended for use in a Pollution Degree 2 industrial environment, in overvoltage Category II applications (as defined in IEC publication 60664-1), at altitudes up to 2000 meters without derating.

This equipment is considered Group 1, Class A industrial equipment according to IEC/CISPR Publication 11. Without appropriate precautions, there may be potential difficulties ensuring electromagnetic compatibility in other environments due to conducted as well as radiated disturbance.

This equipment is supplied as “open type” equipment. It must be mounted within an enclosure that is suitably designed for those specific environmental conditions that will be present and appropriately designed to prevent personal injury resulting from accessibility to live parts. The interior of the enclosure must be accessible only by the use of a tool. Subsequent sections of this publication may contain additional information regarding specific enclosure type ratings that are required to comply with certain product safety certifications.

NOTE: See NEMA Standards publication 250 and IEC publication 60529, as applicable, for explanations of the degrees of protection provided by different types of enclosure. Also, see the appropriate sections in this publication, as well as the Allen-Bradley publication 1770-4.1 (“Industrial Automation Wiring and Grounding Guidelines”), for additional installation requirements pertaining to this equipment.



Preventing Electrostatic Discharge

ATTENTION

This equipment is sensitive to electrostatic discharge, which can cause internal damage and affect normal operation. Follow these guidelines when you handle this equipment:

- Touch a grounded object to discharge potential static.
 - Wear an approved grounding wriststrap.
 - Do not touch connectors or pins on component boards.
 - Do not touch circuit components inside the equipment.
 - If available, use a static-safe workstation.
 - When not in use, store the equipment in appropriate static-safe packaging.
-

North American Hazardous Location Approval

The following information applies when operating this equipment in hazardous locations:	Informations sur l'utilisation de cet équipement en environnements dangereux:
<p>Products marked "CL I, DIV 2, GP A, B, C, D" are suitable for use in Class I Division 2 Groups A, B, C, D, Hazardous Locations and nonhazardous locations only. Each product is supplied with markings on the rating nameplate indicating the hazardous location temperature code. When combining products within a system, the most adverse temperature code (lowest "T" number) may be used to help determine the overall temperature code of the system. Combinations of equipment in your system are subject to investigation by the local Authority Having Jurisdiction at the time of installation.</p>	<p>Les produits marqués "CL I, DIV 2, GP A, B, C, D" ne conviennent qu'à une utilisation en environnements de Classe I Division 2 Groupes A, B, C, D dangereux et non dangereux. Chaque produit est livré avec des marquages sur sa plaque d'identification qui indiquent le code de température pour les environnements dangereux. Lorsque plusieurs produits sont combinés dans un système, le code de température le plus défavorable (code de température le plus faible) peut être utilisé pour déterminer le code de température global du système. Les combinaisons d'équipements dans le système sont sujettes à inspection par les autorités locales qualifiées au moment de l'installation.</p>
<p>WARNING</p> 	<p>EXPLOSION HAZARD</p> <ul style="list-style-type: none"> Do not disconnect equipment unless power has been removed or the area is known to be nonhazardous. Do not disconnect connections to this equipment unless power has been removed or the area is known to be nonhazardous. Secure any external connections that mate to this equipment by using screws, sliding latches, threaded connectors, or other means provided with this product. Substitution of components may impair suitability for Class I, Division 2. If this product contains batteries, they must only be changed in an area known to be nonhazardous.
<p>AVERTISSEMENT</p> 	<p>RISQUE D'EXPLOSION</p> <ul style="list-style-type: none"> Couper le courant ou s'assurer que l'environnement est classé non dangereux avant de débrancher l'équipement. Couper le courant ou s'assurer que l'environnement est classé non dangereux avant de débrancher les connecteurs. Fixer tous les connecteurs externes reliés à cet équipement à l'aide de vis, loquets coulissants, connecteurs filetés ou autres moyens fournis avec ce produit. La substitution de composants peut rendre cet équipement inadapté à une utilisation en environnement de Classe I, Division 2. S'assurer que l'environnement est classé non dangereux avant de changer les piles.

Chapter 1

Introducing the Network Interface Cards

How the 1784-PKTx Card Operates 1-2

Chapter 2

Configuring the PKTx Hardware

Introduction 2-1
Interrupt Request Assignment. 2-1
Base Memory Address Values 2-1
 Setting a Base Memory Address Jumper 2-2
Using Multiple PKTx Cards 2-3
 Planning Jumper Settings for Multiple Cards 2-4
What to Do Next 2-4

Chapter 3

Installing the Card and the Drivers

Accessing the PCI Bus Slots and Installing the Card 3-1
Installing the Plug and Play Drivers 3-2
What to Do Next 3-2

Chapter 4

Connecting the Network Interface Card

1784-PKTX Connections 4-2
1784-PKTXD Connections. 4-3
Before You Begin. 4-4
Connecting to DH+ Devices 4-5
 Connecting the Card to
 an Original PLC-5 Programmable Controller 4-5
 Connecting the Card to an Enhanced PLC-5 Processor. 4-7
 Terminating the Last Node 4-7
 Connecting the Card Using Custom Cabling for DH+ 4-8
Connecting the Card via a DH-485 Network. 4-8
 Connecting the Card to a Single SLC Processor on DH-485. 4-9
 Terminating the Last Node 4-11
Connecting to Remote I/O Devices. 4-11

Interpreting the Status LEDs 4-12
What to Do Next 4-13

Appendix A

Specifications
Index

Introducing the Network Interface Cards

Rockwell Automation 1784-PKT_x family PCI cards connect PCs to PLC controllers on Data Highway Plus (DH+) or SLC processors on DH-485 networks for easy programming and data acquisition. I/O scanner functionality is also available in the cards so they can be used with soft-control or embedded-control engines. And, because these cards incorporate the Universal PCI Card Standard, they are compatible with almost any PC. If general programming, configuration, and monitoring capabilities via an industrial or desktop PC are required, these cards are a necessity.

Your 1784-PKT_x network interface card (cat. nos. 1784-PKTX and 1784-PKTXD) is a PCI (Peripheral Component Interconnect) universal card that must be inserted into a PCI bus slot. A universal card can be placed into a PCI bus slot that is keyed for either 3.3 Volt or 5 Volt signalling. This card may also be placed in a 64-bit slot, although it will not use the extended 64-bit operation. Table 1.1 outlines features supported by the PKT_x cards.

Table 1.1 Features supported by PKT_x cards

KT_x card catalog #	# of channels	Active node on these networks	Remote I/O scanner capability?
1784-PKTX	1	DH+ or DH-485	yes
1784-PKTXD	2	DH+ and/or DH-485 ^①	yes

^① Available only on channel 1

Compatibility

You need a PCI-compatible personal computer. Table 1.2 outlines operating systems and drivers that support the PKT_x cards.

Table 1.2 Operating Systems and drivers supporting the PKT_x cards

	Windows 98 or later	Other operating system
DH+	Included with RSLinx	Write your own driver using 1784-DP4
DH-485	Included with RSLinx	Same as DH+
Remote I/O	Write your own driver using 6001-RIO - RIO Tool Kit	Write your own driver using 6001-RIO - RIO Tool Kit

How the 1784-PKT_x Card Operates

The 1784-PKT_x and -PKT_{XD} cards:

- communicate with nodes on Data Highway Plus networks, including PLC-5[®], PLC-5/250[™], and SLC 5/04 processors, and SLC 5/01[™], SLC 5/02, and SLC5/03 processors (only via 1785-KA5)
- communicate with SLC[™] processors on DH-485 networks
- communicate to DH+ and Remote I/O via SoftLogix-5
- communicate to ControlLogix through a 1756-DHRIO module
- act as a remote I/O scanner

The 1784-PKT_x performs data transmission, management, and local network diagnostics. The interface to the host processor is through a board-resident dual-port memory.

Rockwell Automation RSLinx interface software manages data transmission and reception through dual-port memory.

The PCI BIOS on your computer automatically assigns the PKT_x card's IRQ and base memory address (one for each channel). If your card has two channels, both channels share the same IRQ.

Configuring the PKT_x Hardware

Introduction

The 1784-PKT_x card is a PCI bus card, compliant with the PCI Bus Specification Revision 2.3. This card was developed with Plug and Play functionality, as defined in Revision 1.0A of the Plug and Play BIOS Specification. Because of this, PKT_x cards do not require the use of switches or jumpers to configure their specific interrupt request levels (IRQ) and base memory address values. These configurations are automatically assigned to the PKT_x card by the PCI BIOS when the computer is powered-up. The configurations are stored in the PCI configuration registers. These values may be retrieved by application software used to communicate with the PKT_x card.

Interrupt Request Assignment

The PCI BIOS automatically assigns the PKT_x card an IRQ. Because of this, each time you add or remove cards and restart your computer, the BIOS may assign a different IRQ to each card. You should check the IRQ assignment each time you start your system. Most application software will verify this assignment for you. If you're using RSLinx, its Plug and Play driver verifies the IRQ.

Base Memory Address Values

Although the assignment of the IRQ and base memory address values is automatic, and does not require user intervention, there is one jumper on the PKT_x card that is used to restrict the range of values that can be assigned to the base memory address by the PCI BIOS. This jumper is called the Base Memory Address jumper, and its default position is set to 32 bit. If you are not using Microsoft Windows 95 or later, you may have to set this jumper. See Figure 2.1 on page 2-2.

Figure 2.1 Overview of the jumpers on the PKTx card

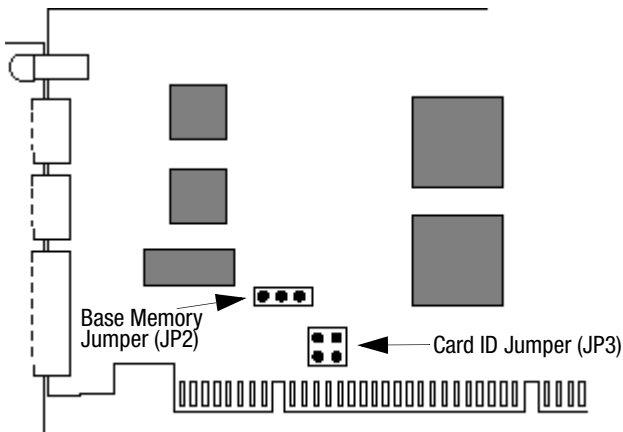

30541-M

Setting a Base Memory Address Jumper

The host computer and the PKTx card exchange data via a dual-port interface. The dual-port requires 4 Kbytes of memory. This 4 Kbyte block of memory begins at the base memory address assigned to the card by the PCI BIOS when the computer is started.

Under MS-DOS, Windows 3.1 and Windows for Workgroups, the base memory address of PC cards should fall within the range of 0 and 1 Megabyte of PC memory. For the newer Windows operating systems, this restriction is no longer required, and the base memory address should be located anywhere in the PC memory space.

The Base Memory Address jumper (JP2) forces the PCI BIOS to assign the base memory address to one of two address ranges, as shown in the table below. You should select the jumper position based on the operating system running on your PC.

When looking directly at the 1784-PKTx card, the Base Memory Address jumper looks like:

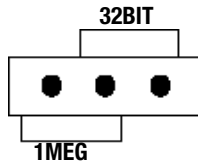

This is a jumper that is not covered.

This is a jumper that has the 32bit position for Windows 95 (or later) covered.

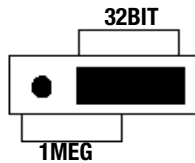

40022

Using Multiple PKTx Cards

It is possible to have more than one PKTx card within your system. You can have **up to four** cards functioning at the same time. There are two jumpers that can be set to establish unique identification between the PKTx cards. The position and combination of the two jumpers allow each card to be uniquely recognized by any application software.

The default position, card ID 0, has both jumpers in place.

Planning Jumper Settings for Multiple Cards

Located on each PKT_x card is a set of jumpers with markings that indicate how each jumper can be set. These jumpers are identified as JP3. It is important to coordinate the setting of these jumpers so that each card can be recognized by the system. Figure 2.2 and the table below show possible combinations of jumper settings that can be used if you have a total of four cards.

Card ID	JP3
0	CID0 and CID1 covered
1	CID0 open, CID1 covered
2	CID0 covered, CID1 open
3	CID0 and CID1 open

Figure 2.2 Examples of covered/open jumpers for all four card IDs

Key



Indicates the jumper is covered



Indicates the jumper is open

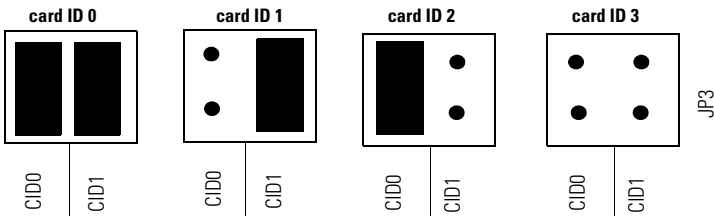

What to Do Next

Chapter 3 tells you how to install a PKT_x card into your computer.

Installing the Card and the Drivers

You've set the jumpers; now you're ready to place the PKT_x card inside your computer and install the plug-n-play drivers.

ATTENTION



Before you can install the PKT_x card, you need to verify that the appropriate jumpers have been set. Refer to chapter 2, *Configuring the PKT_x Hardware*, for more information.

WARNING



If you install or remove the communications card with power applied to this module, an electrical arc can occur. This could cause an explosion in hazardous location installations.

Accessing the PCI Bus Slots and Installing the Card

To install the PKT_x card, you must have access to the computer's PCI bus. Install the card according to your computer manufacturer's instructions.

IMPORTANT

If you disconnect the ac power from the computer, you lose the chassis ground. Electrostatic damage (ESD) protection is lost.

Installing the Plug and Play Drivers

Following these instructions to install your Plug and Play (PnP) drivers:

1. Upon startup, Microsoft Windows should detect the PKTX card and start the 'New Hardware Wizard'. Click **Next**.
2. Insert your RSLinx CD into your CD-ROM drive (if it auto-starts, Exit the RSLinx installation).
3. When prompted by the New Hardware Wizard, select 'Search for a suitable driver...' and click **Next**.
4. When the 'Locate Driver Files' screen appears, select 'Specify a location' and click **Next**.
5. When prompted to specify the location, browse to '**D:\RSLinx\PnP_Drivers**' (where D: is the CD-ROM drive with your RSLinx CD).
6. Follow decision table below:

If your operating system is	browse to	and select file
Microsoft Windows XP or 2000	Win2K\1784-PKTX(D)	pktx2000.inf
Microsoft Windows 9x	Win9x\1784-PKTX(D)	rsipktx.inf

7. Click **OK**.

The screen should indicate the driver has been found.

8. Click **Next**.

You should get a message that Windows has successfully added the PKTX. If not successful, call Rockwell Technical support at 440-646-5800 (if you have an appropriate support contract) or submit a request at <http://support.rockwellautomation.com>.

9. Click **Finish**.

What to Do Next

Chapter 4 explains how to connect the PKT_x card to various networks and devices.

Connecting the Network Interface Card

You can connect the PKT_x card to these networks:

- DH+
- DH-485
- Remote I/O

The purpose of this chapter is to explain:

- what cables can be used to connect to the various networks
- other information needed to connect to a network
- the meanings of the status LEDs

WARNING

If you connect or disconnect the communications cable with power applied to this module or any device on the network, an electrical arc can occur. This could cause an explosion in hazardous location installations.

1784-PKTX Connections

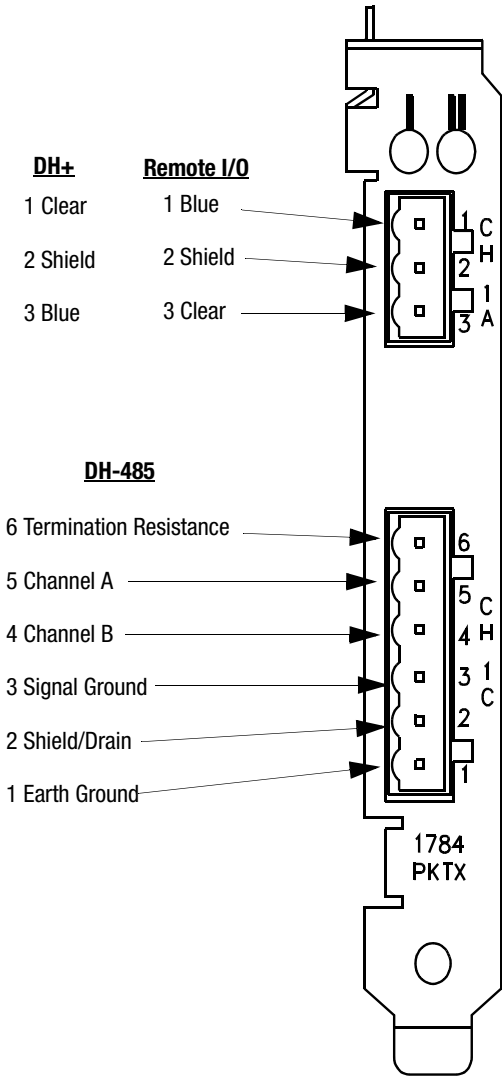

40024

1784-PKTXD Connections

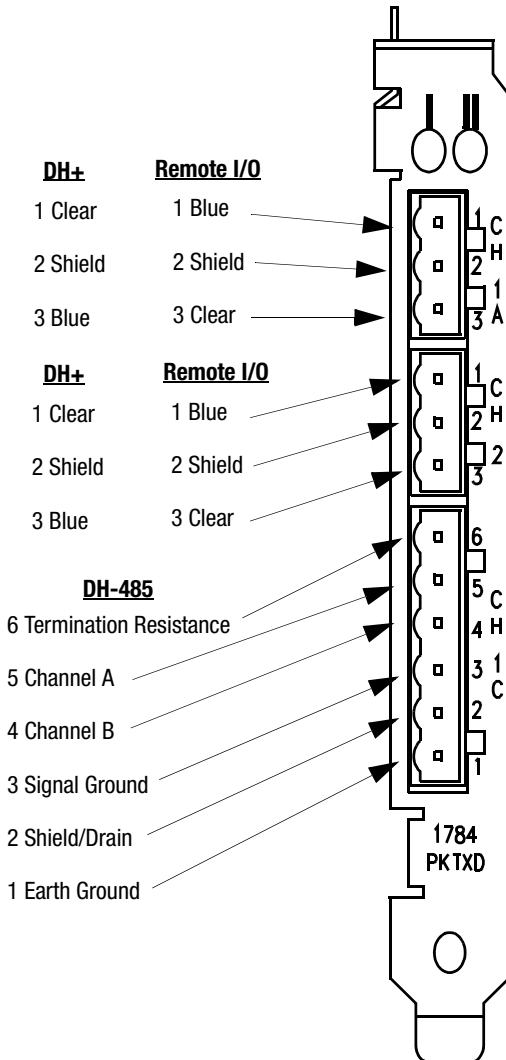

40025

Before You Begin

WARNING



If you connect or disconnect the communications cable with power applied to this module or any device on the network, an electrical arc can occur. This could cause an explosion in hazardous location installations.

Before you make the connections, make sure you have the correct cable.

For connections to:	Use this cable:	And these termination resistors:
Network Cable (build your own)		
Remote I/O	1770-CD ^{①③} Belden #9463	82Ω or 150Ω
DH+	1770-CD ^{①③} Belden #9463	150Ω for 57.6K bits/sec 150Ω for 115.2K bits/sec 82Ω for 230.4K bits/sec
DH-485	Belden #3106A ^{①②}	not needed
Point-to-point Cable (prefabricated)		
Original PLC-5	1784-CP12	not needed
SLC 5/04 processors (direct DH+ connection) Enhanced PLC-5 SLC 5 1756-DHRIO	1784-CP13 (DH+)	not needed
SLC family processors (direct DH-485 connection)	1784-CP14 (DH-485)	not needed

^①Cables used for construction of custom cables
^②Mating Connector: A-B PN 941999-06 or Phoenix Order No. 1849406
^③Mating Connector: A-B PN 941999-03 or Phoenix Order No. 1849396

The 1784-PKTX, -PKTXD card ships with 82Ω and 150Ω resistors and with the DH+/remote I/O and DH-485 mating connectors.

For additional cable information, see these Allen-Bradley publications:

Publication Title	Publication Number
1784-CP12 Cable Packing Data	1784-2.41
1784-CP13 Cable Packing Data	1784-2.44
1784-CP14 Cable Packing Data	1784-2.45

For information about:	See:
Connecting to DH+ devices	page 4-5
Connecting to DH-485 devices	page 4-8
Connecting to remote I/O devices	page 4-11
Interpreting the LEDs	page 4-12

Connecting to DH+ Devices

Depending on your application, you may use the PKT_x card to communicate with a single device or multiple DH+ devices via a DH+ network. This section shows you how to connect to a original or an enhanced PLC-5 programmable controller.

ATTENTION



Not all software and hardware supports 115.2K bit/s or 230.4K bit/s for DH+ communications. Make sure your software and hardware supports the baud rate your select.

For information about:	See:
original programmable controllers	page 4-5
enhanced programmable controllers	page 4-7
terminating the last node	page 4-7
connecting the card to a DH+ network	page 4-8

Connecting the Card to an Original PLC-5 Programmable Controller

To connect the 1784-PKT_x or -PKT_{XD} card to PLC-5 programmable controller, follow these steps:

1. Turn off power to the computer.

IMPORTANT

If you disconnect the ac power from the computer, you lose the chassis ground. Electrostatic damage (ESD) protection is lost.

2. Connect the 3-pin Phoenix end of the CP12 cable to the PKTx card.

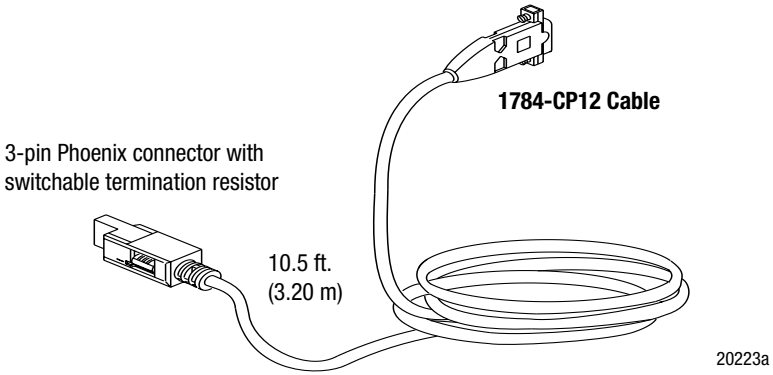

3. Connect the 9-pin D-shell end directly to the 9-pin D-shell connector on the front of the original PLC-5 processor.

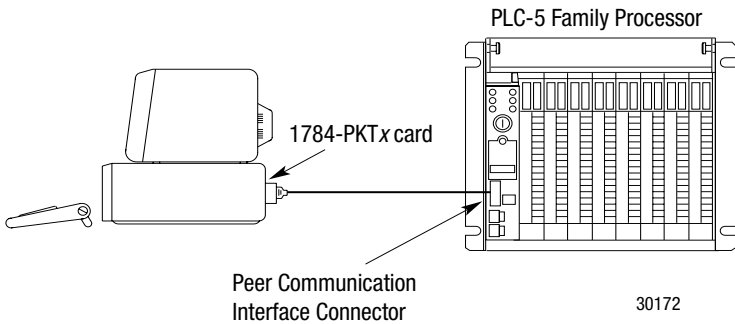

4. Restore power to the computer.

Connecting the Card to an Enhanced PLC-5 Processor

To connect the 1784-PKT_X or -PKT_{XD} card to an enhanced PLC-5 programmable controller, use a 1784-CP13 cable. Follow these steps:

1. Connect the 3-pin Phoenix end of the CP13 cable to the PKT_X card.
2. Connect the adapter to the connector on the front of the enhanced PLC-5 programmable controller.

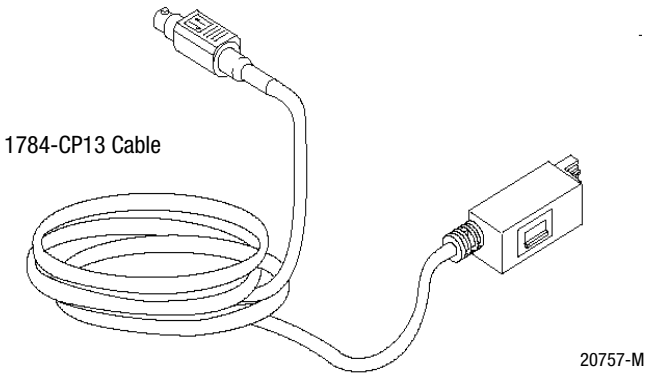

Terminating the Last Node

You must terminate both ends of your DH+ network. If the PKT_X is the last physical node on your network, you must set the switch on the CP12 or 13 to terminate the link as shown below.

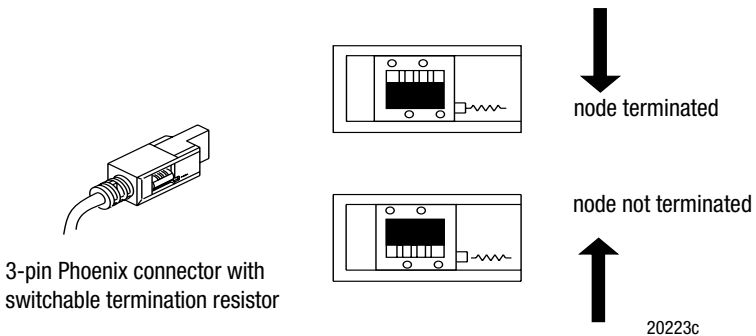

Connecting the Card Using Custom Cabling for DH+

To connect the 1784-PKTX or -PKTXD card to a Data Highway Plus network, use Allen-Bradley 1770-CD or approved cable to construct custom cable. See publication ICCG-2.2, Approved Vendor List for DH, DH+, DH-485, and Remote I/O.

IMPORTANT

You must terminate the last physical node of the network with a resistor of appropriate value.

If all of the devices on your network are capable of operating at 230.4K, use an 82 Ω terminating resistor; otherwise, use a 150 Ω terminating resistor.

Connecting the Card via a DH-485 Network

Figure 4.1 shows an example of a network consisting of three SLC family controllers and one programming station. This configuration requires the 1784-PKTX or -PKTXD card and three link couplers:

- An SLC family CPU is connected to each of the link couplers (1747-AIC) with a 1747-C11 cable.
- The 1784-PKTX or -PKTXD card is connected to the network at one of the link couplers, as shown in Figure 4.1.
- The communication cable consists of three segments of cable daisy-chained at each link coupler.

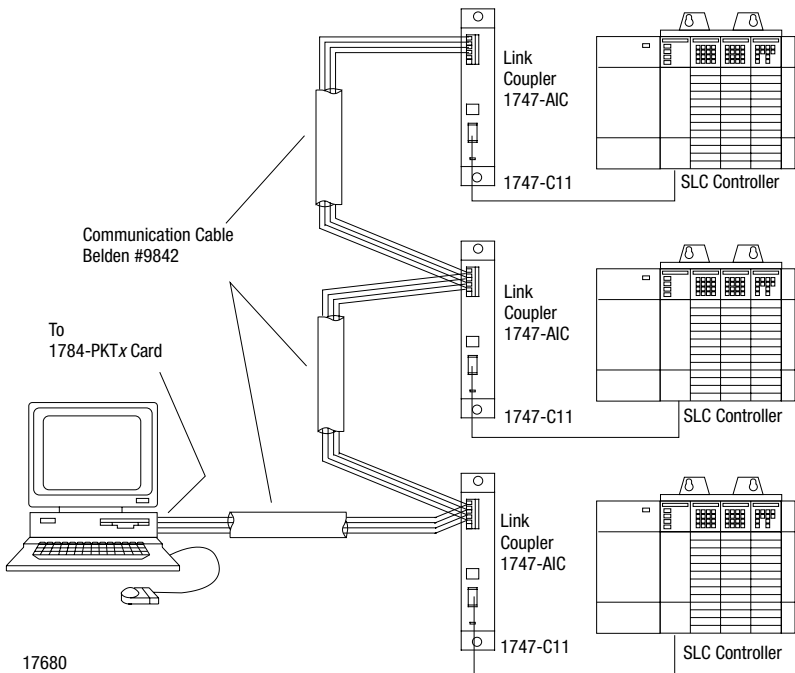
Figure 4.1 Communicating to multiple SLCs via the DH-485 network

Connecting the Card to a Single SLC Processor on DH-485

Figure 4.2 on page 4-10 shows an example of a point-to-point link consisting of an SLC processor and a programming station. This configuration requires the 1784-PKTx or -PKTXD card and an SLC processor. The SLC CPU is connected directly to the 1784-PKTx or -PKTXD card with a 1784-CP14 cable, as shown on page 4-10.

Figure 4.2 Communicating to a single SLC using a point-to-point DH-485 link

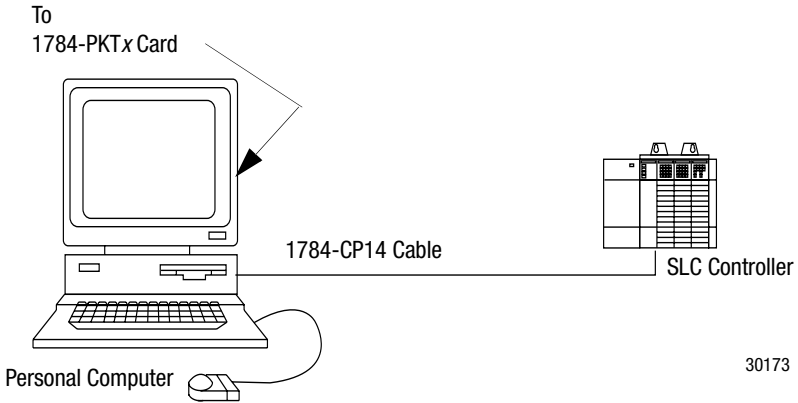

To connect an SLC family processor to the PKT_x card, you:

1. Connect the termination resistor end of the CP14 cable to the PKT_x card
2. Connect the RJ-45 connector directly to the phone-jack connector on the front of the SLC processor.

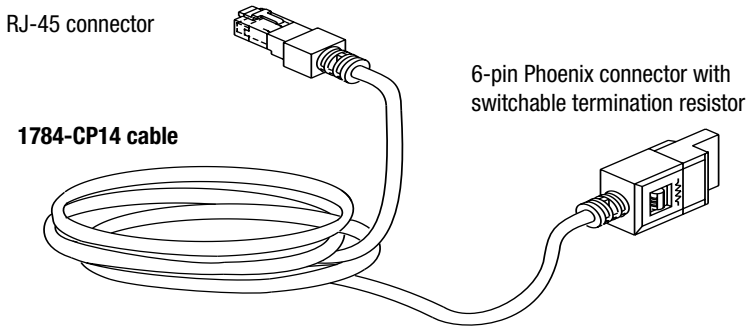

Terminating the Last Node

You must terminate both ends of your DH-485 network. If the PKT_x is the last node on your network, you must set the switch on the CP14 to terminate the link as shown below.

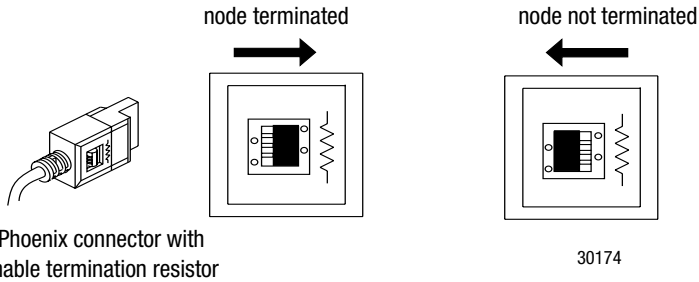

Refer to publication 1770-6.2.2, Data Highway/Data Highway Plus/Data Highway II/Data Highway-485 Cable Installation Manual, for additional information about cable issues.

Connecting to Remote I/O Devices

Depending upon your application, you can use the PKT_x card to communicate with a single device or to multiple devices via a remote I/O link.

To connect the PKT_x card to remote I/O, use Allen-Bradley 1770-CD or approved cable to construct a custom cable. See publication ICCG-2.2 for a list of approved cables.

IMPORTANT

For proper operation, terminate both ends of a remote I/O link by using external resistors. Use either an 82Ω or 150Ω terminator. See Table 4.1.

Table 4.1 Selecting the External Resistor

If your remote I/O link:	use this resistor rating:	The maximum number of:	
		physical devices connected on the link:	racks that you can scan on the link:
operates at 230.4 K bits	82Ω	32	16
operates at 57.6 or 115.2K bit/s, and no devices listed below are linked:			
Scanners: 1771-SN; 1772-SD, -SD2; 1775-SR, -S4A, -S4B; Adapters 1771-AS; 1771-ASB (series A only); 1771-DCM Miscellaneous 1771-AF			
connects to any device listed below:	150Ω	16	16
Scanners 1771-SN; 1772-SD, -SD2; 1775-SR, -S4A, -S4B;			
Adapters 1771-AS; 1771-ASB (series A only); 1771-DCM Miscellaneous 1771-AF			
operates at 57.6 or 115.2K bit/s, and you do not require over 16 physical devices			

Interpreting the Status LEDs

What the LEDs mean depends on which protocol is running. Only the PKTXD uses both LEDs. The left LED (labeled |) is for the top channel on a PKTXD and the other is for the second, lower channel. A PKTX has only one channel (but multiple connectors depending on protocol) so only one LED is used.

Table 4.2 explains the DH+ Status LED. Table 4.3 on page 4-13 explains the DH-485 Status LED. Table 4.4 on page 4-13 explains the Remote I/O Scanner Mode LED.

Table 4.2 DH+ Status LED

LED State	Means
off	channel not online
blinking green	it is the only node on the network
solid green	online and receiving token
blinking red	duplicate node
solid red	failed selftest

Table 4.3 DH485 Status LED

LED State	Means
off	channel not online
blinking green	it is the only node on the network
solid green	online and receiving token
blinking red	parity error
solid red	failed selftest

Table 4.4 Remote I/O Scanner Mode Status LED

LED State	Means
off	channel not online
blinking green	at least one but not all adapters in the scanlist are not responding
solid green	all adapters in the scanlist are responding
blinking red	none of the adapters in the scanlist are responding
solid red	failed selftest

What to Do Next

If you have read each chapter, and still have questions, please call Allen-Bradley Automation Group Technical Support at 440-646-3223.

Notes:

Specifications

1784-PKTX	CH 1A (3-pin Phoenix) runs DH+ and remote I/O CH 1C (6-pin Phoenix) runs DH-485
1784-PKTXD	CH 1A (3-pin Phoenix) runs DH+ and remote I/O CH 1C (6-pin Phoenix) runs DH-485 Ch2 (3-pin Phoenix) runs DH+ and remote I/O
Maximum line lengths and communication rates	<p>DH+: 10,000 ft. (3048 m) @ 57.6K bit/s 5,000 ft. (1,524 m) @ 115.2K bits/s 2,500 ft. (762 m) @ 230.4K bits/s</p> <p>DH-485: 4,000 ft. (1219 m) @ 1200, 2400, 4800, 9600 or 19,200 bits/s</p> <p>remote I/O: 10,000 ft. (3048 m) @ 57.6K bit/s 5,000 ft. (1524 m) @ 115.2K bit/s 2,500 ft. (762 m) @ 230.4K bit/s</p>
Wiring Category ⁽¹⁾	2 - on communications ports
Bus communications	Local PCI (2,3 compliant)
LEDs	1 diagnostic/status LED per channel
Number of modules per system	4 maximum (specified by jumper on card)
Operational Temperature	IEC 60068-2-1 (Test Ad, Operating Cold), IEC 60068-2-2 (Test Bd, Operating Dry Heat), IEC 60068-2-14 (Test Nb, Operating Thermal Shock): 0 to 60°C (32 to 140°F)
Storage Temperature	IEC 60068-2-1 (Test Ab, Un-packaged Non-operating Cold), IEC 60068-2-2 (Test Bb, Un-packaged Non-operating Dry Heat), IEC 60068-2-14 (Test Na, Un-packaged Non-operating Thermal Shock): -40 to 85°C (-40 to 185°F)
Relative Humidity	IEC 60068-2-30 (Test Db, Un-packaged Non-operating Damp Heat): 5 to 95% non-condensing
Vibration	IEC 60068-2-6 (Test Fc, Operating): 2g @ 10-500Hz
Operating Shock	IEC 60068-2-27 (Test Ea, Unpackaged Shock): 30g

A-2 Specifications

Non-Operating Shock	IEC 60068-2-27 (Test Ea, Unpackaged Shock): 50g
Emissions	CISPR 11: Group 1, Class A
ESD Immunity	IEC 61000-4-2: 4kV contact discharges 8kV air discharges
Radiated RF Immunity	IEC 61000-4-3: 10V/m with 1kHz sine-wave 80%AM from 30MHz to 1000MHz
EFT/B Immunity	IEC 61000-4-4: ±2kV at 5kHz on communications ports
Surge Transient Immunity	IEC 61000-4-5: ±2kV line-earth (CM) on shielded ports
Conducted RF Immunity	IEC 61000-4-6: 10Vrms with 1kHz sine-wave 80%AM from 150kHz to 80MHz
Enclosure Type Rating	None (open-style)
Power Dissipation (for the PKTXD)	4.0W 800ma @ 5Vdc
Isolation voltage	Tested to 500Vac for 60 sec
Driver development for remote I/O	6001-RIO, contains binary files and example C code for remote I/O communication
Driver development for DH+ or DH-485	Use the RSLinx PKT.x driver. 1784-DP4, contains binary files and example C code for DH+ or DH-485 communication. (non-Windows)
Agency certification (when product is marked)	c-UR-us UL Recognized Component Industrial Control Equipment for Class I, Division 2 Group A,B,C,D Hazardous Locations, certified for US and Canada CE ⁽²⁾ European Union 89/336/EEC EMC Directive, compliant with: EN 50082-2; Industrial Immunity EN 61326; Meas./Control/Lab., Industrial Requirements EN 61000-6-2; Industrial Immunity EN 61000-6-4; Industrial Emissions C-Tick ⁽²⁾ Australian Radiocommunications Act, compliant with: AS/NZS CISPR 11; Industrial Emissions

(1) Refer to publication 1770-4.1, Industrial Automation Wiring and Grounding Guidelines for Noise Immunity.

(2) See the Product Certification link at www.ab.com for Declarations of Conformity, Certificates, and other certification details.

Numerics

- 1747-C11 cable** 4-8
- 1756-DHRIO module** 1-2
- 1770-CD cable** 4-8
- 1784-CP12 cable** 4-7
- 1784-CP14 cable** 4-9, 4-11
- 1784-PKTx cards**
 - configuring hardware for 2-1
 - connecting to network 4-1
 - features supported by 1-1
 - specifications A-1

B

- base memory address** 2-1
- base memory address setting** 2-1
- BIOS** 2-1

C

- cables**
 - 1784-CP12 4-6
- card ID** 2-4
 - default position 2-3
- compatibility** 1-2
- connecting the interface card**
 - to a DH+ network 4-8
- connections**
 - 1784-PKTx 4-2
 - 1784-PKTXD 4-3
- ControlLogix** 1-2

D

- Data Highway Plus** 4-8
- DH+** 1-1
 - connecting to 4-8
- DH+ network**
 - terminating last node 4-7
- DH-485** 1-1
- DH-485 network**
 - connecting to 4-8

I

- installing the card** 3-1
- installing the Plug and Play drivers** 3-2
- interrupt request** 2-1
- IRQ** 2-1

J

- JP2 jumper** 2-2
- JP3 jumper** 2-4
- jumper**
 - base memory address 2-1
 - setting 2-2
 - card ID 2-3
 - setting 2-4
 - JP2 2-2
 - JP3 2-4

M

- multiple PKTx cards** 2-3

N

- network interface card (NIC)** 1-1
- node termination** 4-7, 4-11

P

- PCI BIOS** 2-1
- PCI bus slot** 1-1
- PCI bus slots** 3-1
- PLC-5 processor**
 - enhanced 4-7
 - original 4-5
- Plug and Play drivers** 3-2
 - files
 - pktx2000.inf 3-2
 - rsipktx.inf 3-2
- programmable controllers** 4-5, 4-7

R

RSLinx 1-2, 2-1

RSLinx CD 3-2

S

SLC family processor 4-10, 4-11

SoftLogix-5 1-2

specifications A-1



How Are We Doing?

Your comments on our technical publications will help us serve you better in the future. Thank you for taking the time to provide us feedback. You can complete this form and mail (or fax) it back to us or email us at RADocumentComments@ra.rockwell.com

Pub. Title/Type 1784-PKTx Communication Card User Manual

Cat. No. 1784-PKTX, 1784-PKTXD Pub. No. 1784-UM527B-EN-P Pub. Date October 2003 Part No. 957726-79

Where applicable, please rank the feature (1=needs improvement, 2=satisfactory, 3=outstanding).

Overall Usefulness	1	2	3	How can we make this publication more useful for you?
Completeness (all necessary information is provided)	1	2	3	Can we add more information to help you?
				<input type="checkbox"/> procedure/step <input type="checkbox"/> illustration <input type="checkbox"/> feature <input type="checkbox"/> example <input type="checkbox"/> guideline <input type="checkbox"/> other <input type="checkbox"/> explanation <input type="checkbox"/> definition
Technical Accuracy (all information is correct)	1	2	3	Can we be more accurate?
				<input type="checkbox"/> text <input type="checkbox"/> illustration
Clarity (all information is easy to understand)	1	2	3	How can we make things clearer?
Other Comments	You can add additional comments on the back of this form.			

Your Name _____ Location/Phone _____

Your Title/Function _____

Would you like us to contact you regarding your comments?

No, there is no need to contact me Yes, please email me at _____
 Yes, please call me Yes, please contact me via _____

Return this form to: Rockwell Automation Technical Communications, 1 Allen-Bradley Dr., Mayfield Hts., OH

Fax: 440-646-3525 Email: RADocumentComments@ra.rockwell.com

PLEASE FASTEN HERE (DO NOT STAPLE)

Other Comments

PLEASE FOLD HERE

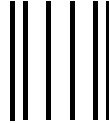

NO POSTAGE
NECESSARY
IF MAILED
IN THE
UNITED STATES

BUSINESS REPLY MAIL

FIRST-CLASS MAIL PERMIT NO. 18235 CLEVELAND OH

POSTAGE WILL BE PAID BY THE ADDRESSEE



**Rockwell
Automation**

**1 ALLEN-BRADLEY DR
MAYFIELD HEIGHTS OH 44124-9705**

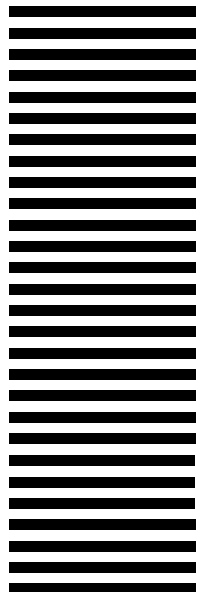

Rockwell Automation Support

Rockwell Automation provides technical information on the web to assist you in using our products. At <http://support.rockwellautomation.com>, you can find technical manuals, a knowledge base of FAQs, technical and application notes, sample code and links to software service packs, and a MySupport feature that you can customize to make the best use of these tools.

For an additional level of technical phone support for installation, configuration and troubleshooting, we offer TechConnect Support programs. For more information, contact your local distributor or Rockwell Automation representative, or visit <http://support.rockwellautomation.com>.

Installation Assistance

If you experience a problem with a hardware module within the first 24 hours of installation, please review the information that's contained in this manual. You can also contact a special Customer Support number for initial help in getting your module up and running:

United States	1.440.646.3223 Monday – Friday, 8am – 5pm EST
Outside United States	Please contact your local Rockwell Automation representative for any technical support issues.

New Product Satisfaction Return

Rockwell tests all of our products to ensure that they are fully operational when shipped from the manufacturing facility. However, if your product is not functioning and needs to be returned:

United States	Contact your distributor. You must provide a Customer Support case number (see phone number above to obtain one) to your distributor in order to complete the return process.
Outside United States	Please contact your local Rockwell Automation representative for return procedure.

www.rockwellautomation.com

Power, Control and Information Solutions Headquarters

Americas: Rockwell Automation, 1201 South Second Street, Milwaukee, WI 53204-2496 USA, Tel: (1) 414.382.2000, Fax: (1) 414.382.4444

Europe/Middle East/Africa: Rockwell Automation, Vorstlaan/Boulevard du Souverain 36, 1170 Brussels, Belgium, Tel: (32) 2 663 0600, Fax: (32) 2 663 0640

Asia Pacific: Rockwell Automation, Level 14, Core F, Cyberport 3, 100 Cyberport Road, Hong Kong, Tel: (852) 2887 4788, Fax: (852) 2508 1846

Publication 1784-UM527B-EN-P - October 2003

PN 957726-79

Supersedes Publication 1784-6.5.27 - September 1997

Copyright © 2003 Rockwell Automation, Inc. All rights reserved. Printed in USA